





Test Report No.:	LD190808N030-1
Client	
Name :	Shenzhen SOFAR SOLAR Co., Ltd.
Address :	401, Building 4, AnTongDa Industrial Park, District 68, XingDong Community, XinAn Street, BaoAn District, Shenzhen, China.
Test Item :	Hybrid inverter
Identification :	HYD 6000-ES, HYD 5000-ES, HYD 4600-ES, HYD 4000-ES, HYD 3600-ES, HYD 3000-ES
Testing laboratory	
Name :	Bureau Veritas Shenzhen Co., Ltd. Dongguan Branch
Address :	No. 34, Chenwulu Section, Guantai Rd., Houjie Town, Dongguan City, Guangdong 523942, China
Test specification	
Standard :	IEC 62040-1: 2008 (1st edition)
Test Result :	The test item passed.
Prepared By :	
	

	Dora Zhang
	Project Engineer / Safety Department
	2019-08-15
	Date
Approved By:	
	

	James Huang
	Technical Manger / Safety Department
	2019-08-15
	Date
<small>This report is governed by, and incorporates by reference, CPS Conditions of Service as posted at the date of issuance of this report at http://www.bureauveritas.com/home/about-us/our-business/cps/about-us/terms-conditions and is intended for your exclusive use. Any copying or replication of this report to or for any other person or entity, or use of our name or trademark, is permitted only with our prior written permission. This report sets forth our findings solely with respect to the test samples identified herein. The results set forth in this report are not indicative or representative of the quality or characteristics of the lot from which a test sample was taken or any similar or identical product unless specifically and expressly noted. Our report includes all of the tests requested by you and the results thereof based upon the information that you provided to us. Measurement uncertainty is only provided upon request for accredited tests. You have 60 days from date of issuance of this report to notify us of any material error or omission caused by our negligence or if you require measurement uncertainty; provided, however, that such notice shall be in writing and shall specifically address the issue you wish to raise. A failure to raise such issue within the prescribed time shall constitute your unqualified acceptance of the completeness of this report, the tests conducted and the correctness of the report contents.</small>	



TEST REPORT

IEC 62040-1

**Uninterruptible power systems (UPS) –
Part 1: General and safety requirements for UPS**

Report

Reference No : **LD190808N030-1**

Compiled by (+ signature) See cover sheet

Approved by (+ signature) See cover sheet

Date of issue 2019-08-15

Testing Laboratory

Name : **Bureau Veritas Shenzhen Co., Ltd. Dongguan Branch**

Address : No. 34, Chenwulu Section, Guantai Rd., Houjie Town, Dongguan City, Guangdong 523942, China

Testing Location : **Bureau Veritas Shenzhen Co., Ltd. Dongguan Branch**

Address : No. 34, Chenwulu Section, Guantai Rd., Houjie Town, Dongguan City, Guangdong 523942, China

Applicant's

Name : **Shenzhen SOFAR SOLAR Co., Ltd.**

Address : 401, Building 4, AnTongDa Industrial Park, District 68, XingDong Community, XinAn Street, BaoAn District, Shenzhen, China.

Test specification

Standard : IEC 62040-1:2008 (1st Edition)

Test procedure : IEC

Procedure deviation : N/A

Non-standard test method : N/A

Test Report Form No : IEC62040_1A

TRF originator : TÜV Rheinland Japan Ltd.

Master TRF : Dated 2009-11

Test item

Description : **Hybrid inverter**

Trademark :



Manufacturer : Shenzhen SOFAR SOLAR Co., Ltd.

Model and/or type reference : HYD 6000-ES, HYD 5000-ES, HYD 4600-ES, HYD 4000-ES, HYD 3600-ES, HYD 3000-ES



Ratings	HYD 6000-ES	HYD 5000-ES	HYD 4600-ES
Full load MPP DC voltage range [V] :	300-520	250-520	230-520
Input DC voltage range[V]..... :	90 - 580		
Input DC current [A]	Max. 12.0 x 2		
Output AC voltage [V]..... :	230, 50Hz		
Output AC current [A]..... :	Max. 27.3	Max.22.8	Max.21.0
Output power [VA]..... :	6000	5000	4600
Output DC voltage range [V]	42-58Vdc		
[Battery charge]..... :			
Input DC current [A]	Max.65A		
[Battery charge]..... :			
Output DC current [A]..... :	Max. 70A		
[Battery discharge]..... :			
Charge and discharge power[VA] :	Max. 3000		
Output AC voltage [V]..... :	230Vac, 50Hz		
Output AC current [A]..... :	Max.13.2		
Output power [VA]..... :	3000		

Ratings	HYD 4000-ES	HYD 3600-ES	HYD 3000-ES
Full load MPP DC voltage range [V] :	200-520	180-520	160-520
Input DC voltage range[V]..... :	90 - 580		
Input DC current [A]..... :	Max. 12.0 x 2		
Output AC voltage [V]..... :	230, 50Hz		
Output AC current [A]	Max.18.2	Max.16.0	Max. 13.7
Output power [VA]..... :	4000	3680	3000
Output DC voltage range [V]	42-58Vdc		
[Battery charge]..... :			
Input DC current [A]..... :	Max.65A		
[Battery charge]..... :			
Output DC current [A]..... :	Max. 70A		
[Battery discharge]..... :			
Charge and discharge power[VA] :	Max. 3000		
Output AC voltage [V]..... :	230Vac, 50Hz		
Output AC current [A]	Max.13.2		
Output power [VA]..... :	3000		



Particulars: test item vs. test requirements	
Equipment mobility	<input type="checkbox"/> movable <input type="checkbox"/> stationary <input type="checkbox"/> for building-in <input checked="" type="checkbox"/> fixed
Connection to the mains	<input type="checkbox"/> pluggable equipment <input checked="" type="checkbox"/> permanent connection <input type="checkbox"/> detachable power supply cord <input type="checkbox"/> non-detachable power supply cord
Operating condition.....	<input checked="" type="checkbox"/> continuous <input type="checkbox"/> rated operating / resting time:
Access location	<input type="checkbox"/> operator accessible <input checked="" type="checkbox"/> restricted access location
Over voltage category (OVC)	<input type="checkbox"/> OVC I <input checked="" type="checkbox"/> OVC II <input checked="" type="checkbox"/> OVC III <input type="checkbox"/> OVC IV <input type="checkbox"/> other:
Mains supply tolerance (%) or absolute mains supply values	-90 / +110 %
Tested for IT power systems	<input type="checkbox"/> Yes <input checked="" type="checkbox"/> No
IT testing, phase-phase voltage (V)	--
Class of equipment	<input checked="" type="checkbox"/> Class I <input type="checkbox"/> Class II <input type="checkbox"/> Not classified
Considered current rating (A)	--
Pollution degree (PD)	<input type="checkbox"/> PD 1 <input checked="" type="checkbox"/> PD 2 <input type="checkbox"/> PD 3
IP protection class	IP 65
Altitude during operation (m)	<2000
Altitude of test laboratory (m)	150
Mass of equipment (kg)	Approx. 20.5
Test case verdicts	
Test case does not apply to the test object :	N/A
Test item does meet the requirement	P(ass)
Test item does not meet the requirement ...:	F(ail)
Testing	
Date of receipt of test item	2018-09-03 & 2019-08-08
Date(s) of performance of test	2018-09-03 to 2018-09-20 & 2019-08-08 to 2019-08-10



General remarks

The test result presented in this report relate only to the object(s) tested.
This report shall not be reproduced, except in full, without the written approval of the Issuing testing laboratory.

"(see Enclosure #)" refers to additional information appended to the report.

"(see appended table)" refers to a table appended to the report.

Report history:

Remark 1	This test report is to replace the original test report LD180903N042-1-R1. issue by Bureau Veritas Shenzhen Co., Ltd. Dongguan Branch, on 04, Feb., 2018.
Remark 2	The modification applied on this report is: <ul style="list-style-type: none">- Add new model HYD 4600-ES.- Change all the lables: the product parameters has not changed.- Change the applicant's address.
Remark 3	For the above "Remark 2" described changes, clause 4.6 electrical data (in normal conditions) were considered necessary.

Throughout this report a point is used as the decimal separator.

Standard IEC 62040-1:2008 is to be used in conjunction with IEC 60950-1:2005, which is referred to in this TRF by "RD".



General product information:

The Hybrid inverter is a single-phase type and only one machine is allowed on each line conductor.

The input and output are protected by varistors to Earth. The unit is providing EMC filtering at the PV input and output toward mains. The unit does not provide galvanic separation from input to output (transformerless). The output is switched off redundantly by the high power switching bridge and two relays. This assures that the opening of the output circuit will also operate in case of a single error.

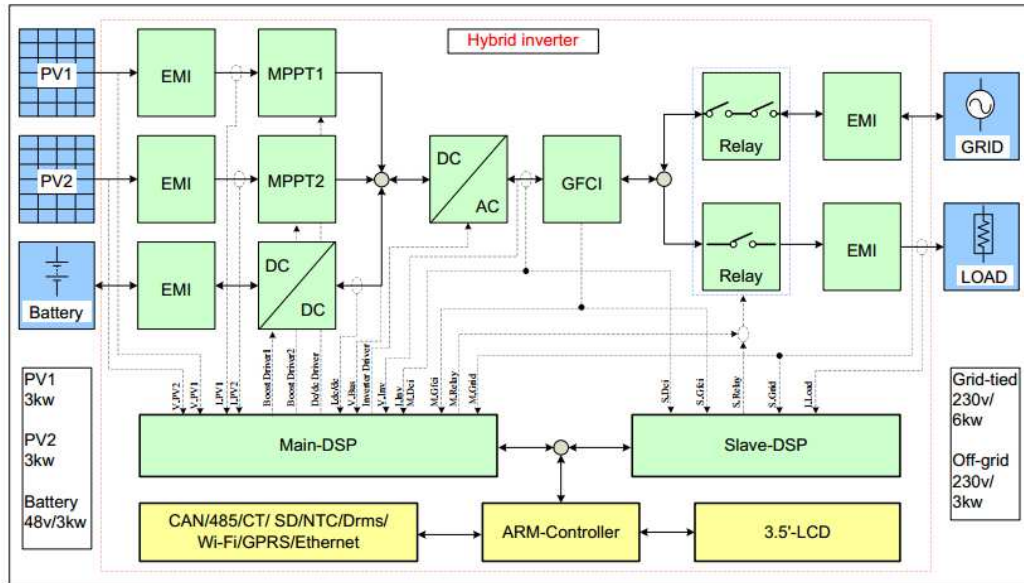

Figure 1 – Block diagram

The internal control is redundant built. It consists of Microcontroller Main DSP (U4) and slave DSP (U22).

The Main DSP (U4) control the relays by switching signals; measures the PV voltage, PV current, Bus voltage, grid voltage, frequency, AC current with injected DC and the array insulation resistance to ground. In addition it tests the current sensors and the RCMU circuit before each start up.

The slave DSP (U22) is measures the grid voltage, grid frequency and residual current, also can switch off the relays independently, and communicate with Main DSP (U4) each other.

The current is measured by a current sensor. The AC current signal and the injected DC current signal are sent to the Main DSP(U4). The Main DSP(U4) tests and calibrates before each start up all current sensors. The unit provides two relays in series in all output conductors. When single fault applied to one relay, alarm an error code in display panel, another redundant relay provides basic insulation maintained between the PV array and the mains. All the relays are tested before each start up.

The models HYD 3000-ES, HYD 3600-ES, HYD 4000-ES, HYD 4600-ES ,HYD 5000-ES and HYD 6000-ES are completely identical and output power derated by software, except for the following table.



Modle	HYD 6000-ES	HYD 5000-ES	HYD 4600-ES	HYD 4000-ES	HYD 3600-ES	HYD 3000-ES
Resistance (R332,R334,R336,R338)	(0Ω, NC, 0Ω,0Ω)			(NC, 0Ω, NC, 0Ω)		
Bus capacitance	8 pcs			6pcs		
INV inductor (R190)	0.75mH 30kΩ			1.035mH 40.2kΩ		
(R123,R132)	(1.5kΩ, 1.5kΩ)			(499Ω, 499Ω)		

The product was tested on:

Hardware version: V1.0

Software version: V1.00

Test condition:

Temperature: 20±5°C

Relative humidity: 60%

Air pressure: 950 mbar

The test sample was a pre-production sample without serial number.



IEC 62040-1			
Clause	Requirement – Test	Result – Remark	Verdict

4	GENERAL CONDITIONS FOR TESTS		P
---	------------------------------	--	---

4.5	Components		P
	Comply with IEC 62040-1 or relevant component standard	(see appended table 4.5)	P
1.5.2/RD	Evaluation and testing of components		P
1.5.3/RD	Thermal controls		N/A
1.5.4/RD	Transformers	Transformers used are suitable for their intended application and comply with the relevant requirements of the standard and particularly Annex C	P
1.5.5/RD	Interconnecting cables		P
1.5.6/RD	Capacitors bridging insulation	Approved X,Y capacitor used in PCS	P
1.5.7/RD	Resistors bridging insulation		P
1.5.7.1/RD	Resistors bridging functional, basic or supplementary insulation		N/A
1.5.7.2/RD	Resistors bridging double or reinforced insulation between a.c. mains and other circuits	A group of resistors used in PCS for voltage sampling	P
1.5.7.3/RD	Resistors bridging double or reinforced insulation between a.c. mains and antenna or coaxial cable		N/A
1.5.8/RD	Components in equipment for IT power systems		N/A

4.6	Power interface		P
1.6.1/RD	AC power distribution systems		P
1.6.2/RD	Input current	(see appended table 4.6)	P
4.6 1.6.4/RD	Neutral conductor		P

4.7	Marking and instructions		P
4.7.1	General		P
4.7.2	Power rating	All required markings are affixed on labels or marking on enclosure.	P
	Input rated voltage/range (V).....:	For AC input side: 230Vac, N/PE	P



IEC 62040-1			
Clause	Requirement – Test	Result – Remark	Verdict
	Input rated current/range (A)	For AC input side: 27.4A for ac side For PV input side: 12x12 d.c. A For Battery input side: 65A	P
	Input symbol for nature of supply (d.c.)	For PV input side: 90-580 d.c. V For Battery input side: 42-58d.c. V	P
	Input rated frequency/range (Hz).....	50Hz	P
1.7.1/RD	Number of Input phases and neutral	N/PE	P
	Output rated voltage/range (V)	230Vac. for AC side.	P
	Output rated current/range (A)	HYD 6000-ES: Max.27.3 HYD 5000-ES: Max.22.8 HYD 4600-ES: Max.21.0 HYD 4000-ES: Max.18.2 HYD 3600-ES: Max.16.0 HYD 3000-ES: Max.13.7	P
	Output rated power factor, (if less than unity, or active power and apparent power or active power and rated current)	Default is 1, but it is adjustable (0.8 leading to 0.8 lagging) for some countries.	P
1.7.1/RD	Number of output phases and neutral	N/PE	P
	Output rated active power (W)	For AC side: HYD 6000-ES: 6000VA HYD 5000-ES: 5000VA HYD 4600-ES: 4600VA HYD 4000-ES: 4000VA HYD 3600-ES: 3600VA HYD 3000-ES: 3000VA For Battery DC side: 3000W	P
	Output rated apparent power (VA)		N/A
	Output symbol for nature of supply (d.c.)	AC use symbol ac. DC use symbol dc.	P
	Output rated frequency/range (Hz).....	50Hz	P
	Ambient operating temperature range (°C)	-25°C to +60°C	P
	Manufacturer's name or trademark or identification mark		P
	Type/model or type reference.....	HYD 6000-ES, HYD 5000-ES, HYD 4600-ES, HYD 4000-ES, HYD 3600-ES, HYD 3000-ES	P
	Symbol for Class II equipment only	Class I equipment.	N/A
	Other symbols	Series No.	P
	Certification marks	CE	N/A



IEC 62040-1			
Clause	Requirement – Test	Result – Remark	Verdict
	Instructions for units with automatic bypass/maintenance bypass, additional input a.c. supply, or external batteries, having text "See installation instructions before connecting to the supply"		N/A
4.7.3	Safety instructions	The user manual contains information for operation, installation, servicing, transport storage and technical data.	P
4.7.3.1	General		P
4.7.3.2	Installation	The battery terminals are considered as hazardous live parts, it should be evaluated in the end product.	P
	Location in a restricted access location only ... :	Mounted in restricted access location only, see user manual.	P
	Permanent connector UPS..... :	See user manual.	P
	Pluggable type A or Pluggable type B UPS	Permanent connection.	N/A
4.7.3.3	Operation..... :	Only the Trained personnel can install and operate.	P
4.7.3.4	Maintenance	For all repair and maintenance always return the unit to an authorized Service Center.	P
4.7.3.5	Distribution related backfeed..... :	Considered.	P
4.7.4 1.7.4/RD	Main voltage adjustment	No such device.	N/A
	Methods and means of adjustment; reference to installation instructions		N/A
4.7.5 1.7.5/RD	Power outlets..... :	No such device.	N/A
4.7.6 1.7.6/RD	Fuse identification (marking, special fusing characteristics, cross-reference)	Considered.	P
4.7.7 1.7.7/RD	Wiring terminals		P
1.7.7.1/RD	Protective earthing and bonding terminals	The symbol of  was marked on the terminal block for connection of protective earthing conductor.	P
1.7.7.2/RD	Terminals for a.c. mains supply conductors	The marking and indication of the AC mains supply neutral conductor on junction box cover are located that indication of function is clearly.	P



IEC 62040-1			
Clause	Requirement – Test	Result – Remark	Verdict
1.7.7.3/RD	Terminals for d.c. mains supply conductors	The marking and indication of the DC mains supply neutral conductor on junction box cover are located that indication of function is clearly.	P
4.7.8	Battery terminals	The symbols of polarity of battery terminals are according to IEC60417, Nos. 5005 and 5006 (+ and -).	P
4.7.9 1.7.8/RD	Controls and indicators		P
1.7.8.1/RD	Identification, location and marking	The relevant messages are showed on LCD display.	P
1.7.8.2/RD	Colours		N/A
1.7.8.3/RD	Symbols according to IEC 60417	“ON” indicated the on-position of DC switch. “OFF” indicated the off-position of DC switch.	P
1.7.8.4/RD	Markings using figures		N/A
4.7.10 1.7.9/RD	Isolation of multiple power sources	Considered.	P
4.7.11 1.7.2.4/RD	IT power systems	Equipment is not intended connected IT power systems.	N/A
4.7.12	Protection in building installation	Suitable information provided in the “Installation Manual”	P
4.7.13 5.1/RD	High leakage current (mA)		P
4.7.14 1.7.10/RD	Thermostats and other regulating devices	The NTC device was not adjustable.	N/A
4.7.15 1.7.2.1/RD and 1.7.8.1/RD	Language(s)	Safety instructions and markings were in English language. Other languages will be provided when submitted for national approval.	—
4.7.16 1.7.11/RD	Durability of markings	The label and markings were subjected to the permanence of marking test. The label and marking were rubbed with cloth soaked with water for 15s and then again for 15s with the cloth soaked with petroleum spirit. After this test there was no damage to the label. The marking on the label and silk printing did not fade. There was no curling nor lifting of the label edge.	P



IEC 62040-1			
Clause	Requirement – Test	Result – Remark	Verdict
4.7.17 1.7.12/RD	Removable parts	No removable parts.	P
4.7.18 1.7.13/RD	Replaceable batteries	No replaceable batteries.	N/A
	Language(s)	English	—
4.7.19 1.7.2.5/RD	Operator access with a tool.....	Considered.	P
4.7.20	Battery	Gel battery and lithium battery of external battery pack (EBP) used.	P
	Clearly legible information	The explanations are provided in the manual.	P
	Battery type	The explanations are provided in the manual.	P
	Nominal voltage of total battery (V)	Li-ion or lead-acid Battery can be used.	P
	Nominal capacity of total battery (optional)	Detailed information regarding external interfaces provided in the "Installation Manual".	P
	Warning label	The explanations are provided in the manufacturer's EBP of manual.	N/A
	Instructions	See above.	N/A
2.1.1.5/RD	Protection against energy hazards	No any energy hazards in operator access area.	N/A
4.7.21 1.7.2.4/RD	Installation instructions	Detailed information regarding external interfaces provided in the "Installation Manual".	P

5	FUNDAMENTAL DESIGN REQUIREMENTS		P
5.1	Protection against electric shock and energy hazards		P
5.1.1 2.1.1/RD	Protection for UPS intended to be used in operator access areas		P
2.1.1.1/RD	Access to energized parts		P
	Test by inspection		P
	Test with test finger (Figure 2A)		P
	Test with test pin (Figure 2B)		P
	Test with test probe (Figure 2C)		N/A
2.1.1.2/RD	Battery compartments	No TNV circuits existed in battery compartments	N/A
2.1.1.3/RD	Access to ELV wiring		N/A
	Working voltage (V _{peak} or V _{rms}); minimum distance through insulation (mm)		P



IEC 62040-1			
Clause	Requirement – Test	Result – Remark	Verdict

2.1.1.4/RD	Access to hazardous voltage circuit wiring	No any hazardous voltage circuit wiring can be accessed by operator	P
2.1.1.5/RD	Energy hazards	No energy hazard at operator accessible SELV interface	P
2.1.1.6/RD	Manual controls	No conductive controls or handles or alike provided	P
2.1.1.7/RD	Discharge of capacitors in equipment		P
	Measured voltage (V); time-constant (s)		—
2.1.1.8/RD	Energy hazards – d.c. mains supply		N/A
	a) Capacitor connected to the d.c. mains supply		N/A
	b) Internal battery connected to the d.c. mains supply		N/A
2.1.1.9/RD	Audio amplifiers		N/A
5.1.2 2.1.1.5 c) /RD	Protection for UPS intended to be used in service access areas		N/A
	Hazardous energy level		N/A
5.1.3 2.1.1.5 c) /RD	Protection for UPS intended to be used in restricted access areas		P
	Hazardous energy level		N/A
5.1.4	Backfeed protection		—
	Shock hazard after de-energization of a.c. input for UPS		N/A
	Measured voltage (V); time-constant (s)		—
	Description of the construction		N/A
5.1.5	Emergency switching device		N/A

5.2	Requirements for auxiliary circuits		P
5.2.1 2.2/RD	Safety extra low voltage circuit - SELV		P
2.2.1/RD	General requirements		P
2.2.2/RD	Voltages under normal conditions (V)	(See appended table 5.2.1)	P
2.2.3/RD	Voltages under fault conditions (V)	(See appended table 5.2.1)	P
2.2.4/RD	Connection of SELV circuits to other circuits ..	SELV	P
5.2.2 2.3/RD	Telephone network voltage circuits - TNV		N/A



IEC 62040-1			
Clause	Requirement – Test	Result – Remark	Verdict
2.3.1/RD	Limits		N/A
	Type of TNV circuits		—
2.3.2/RD	Separation from other circuits and from accessible parts		N/A
2.3.2.1/RD	General requirements		N/A
2.3.2.2/RD	Protection by basic insulation		N/A
2.3.2.3/RD	Protection by earthing		N/A
2.3.2.4/RD	Protection by other constructions		N/A
2.3.3/RD	Separation from hazardous voltages		N/A
	Insulation employed.....		—
2.3.4/RD	Connection of TNV circuits to other circuits		N/A
	Insulation employed.....		—
2.3.5/RD	Test for operating voltages generated externally		N/A
	Test with test probe (Figure 2C)		N/A
5.2.3 2.4/RD	Limited current circuits		N/A
2.4.1/RD	General requirements		N/A
2.4.2/RD	Limit values	(See appended table 5.2.3)	—
	Frequency (Hz)		—
	Measured current (mA)		—
	Measured voltage (V)		—
	Measured circuit capacitance (nF or μF).....		—
2.4.3/RD	Connection of limited current circuits to other circuits		N/A
5.2.4 3.5/RD	External signalling circuits		N/A
3.5.1/RD	General requirements		N/A
3.5.2/RD	Types of interconnection circuits		N/A
3.5.3/RD	ELV circuits as interconnection circuits		N/A
3.5.4/RD	Data ports for additional equipment		N/A
5.2.5 2.5/RD	Limited power source		N/A
	a) Inherently limited output		N/A
	b) Impedance limited output		N/A
	c) Regulating network limited output under normal operating and single fault condition		N/A



IEC 62040-1			
Clause	Requirement – Test	Result – Remark	Verdict

	d) Overcurrent protective device limited output		N/A
	Max. output voltage (V), max. output current (A), max. apparent power (VA)..... :		—
	Current rating of overcurrent protective device (A)		—

5.3	Protective earthing and bonding		P
5.3.1	General		P
2.6/RD	Provisions for earthing and bonding		P
2.6.1/RD	Protective earthing		P
2.6.2/RD	Functional earthing		N/A
2.6.3/RD	Protective earthing and protective bonding conductors		P
2.6.3.1/RD	General		P
2.6.3.2/RD	Size of protective earthing conductors		P
	Rated current (A), cross-sectional area (mm ²), AWG..... :		—
2.6.3.3/RD	Size of protective bonding conductors		P
	Rated current (A), cross-sectional area (mm ²), AWG..... :		—
	Protective current rating (A), cross-sectional area (mm ²), AWG..... :		—
2.6.3.4/RD	Resistance of earthing conductors and their terminations; resistance (Ω), voltage drop (V), test current (A), duration (min)	See appended table	P
2.6.3.5/RD	Colour of insulation..... :		P
2.6.4/RD	Terminals		P
2.6.4.1/RD	General		P
2.6.4.2/RD	Protective earthing and bonding terminals		P
	Rated current (A), type, nominal thread diameter (mm)..... :		—
2.6.4.3/RD	Separation of the protective earthing conductor from protective bonding conductors		P
2.6.5/RD	Integrity of protective earthing		P
2.6.5.1/RD	Interconnection of equipment		P
2.6.5.2/RD	Components in protective earthing conductors and protective bonding conductors		P
2.6.5.3/RD	Disconnection of protective earth		P



IEC 62040-1			
Clause	Requirement – Test	Result – Remark	Verdict

2.6.5.4/RD	Parts that can be removed by an operator		P
2.6.5.5/RD	Parts removed during servicing		P
2.6.5.6/RD	Corrosion resistance		P
2.6.5.7/RD	Screws for protective bonding		P
2.6.5.8/RD	Reliance on telecommunication network or cable distribution system		N/A
5.3.2 2.6.1/RD	Protective earthing		P
2.10/RD	Clearances, creepage distances and distances through insulation		P
4.2/RD	Mechanical strength		P
5.2/RD	Electric strength		P
5.3.3	Protective bonding		P

5.4	AC and d.c. power isolation		P
5.4.1	General		P
3.4/RD	Disconnection from the mains supply		P
3.4.1/RD	General requirement		P
3.4.2/RD	Disconnect devices		P
3.4.3/RD	Permanently connected equipment	External circuit breaker required	P
3.4.4/RD	Parts which remain energized		P
3.4.5/RD	Switches in flexible cords		N/A
3.4.6/RD	Number of poles - single-phase and d.c. equipment		N/A
3.4.7/RD	Number of poles - three-phase equipment		N/A
3.4.8/RD	Switches as disconnect devices		P
3.4.9/RD	Plugs as disconnect devices		N/A
3.4.10/RD	Interconnected equipment		N/A
3.4.11/RD	Multiple power sources		P
5.4.2	Disconnect devices		P

5.5	Overcurrent and earth fault protection		P
5.5.1	General		P
2.7.3/RD	Short-circuit backup protection		P
2.7.4/RD	Number and location of protective devices :	External circuit breaker required	P
2.7.5/RD	Protection by several devices		N/A



IEC 62040-1			
Clause	Requirement – Test	Result – Remark	Verdict

2.7.6/RD	Warning to service personnel		N/A
5.5.2	Basic requirements		P
5.5.3	Battery circuit protection		P
5.5.3.1	Overcurrent and earth fault protection		P
5.5.3.2	Location of protective device		P
5.5.3.3	Rating of protective device		P
5.3.1/RD	Protection against overload and abnormal operation	(see appended table 8.3)	P

5.6	Protection of personnel – Safety interlocks		N/A
5.6.1	Operator protection	No such device.	N/A
2.8/RD	Safety interlocks		N/A
2.8.1/RD	General principles		N/A
2.8.2/RD	Protection requirements		N/A
2.8.3/RD	Inadvertent reactivation		N/A
2.8.4/RD	Fail-safe operation		N/A
2.8.5/RD	Moving parts		N/A
2.8.6/RD	Overriding		N/A
2.8.7/RD	Switches and relays		N/A
2.8.7.1/RD	Contact gaps (mm)		N/A
2.8.7.2/RD	Overload test		N/A
2.8.7.3/RD	Endurance test		N/A
2.8.7.4/RD	Electric strength test		N/A
2.8.8/RD	Mechanical actuators		N/A
5.6.2	Service person protection		N/A
5.6.2.1	Introduction		N/A
5.6.2.2	Covers		N/A
5.6.2.3	Location and guarding of parts		N/A
5.6.2.4	Parts on doors		N/A
5.6.2.5	Component access		N/A
2.8.3/RD	Inadvertent reactivation		N/A
5.6.2.6	Moving parts		N/A
5.6.2.7	Capacitor banks		N/A
5.6.2.8	Internal batteries		N/A



IEC 62040-1			
Clause	Requirement – Test	Result – Remark	Verdict

5.7 2.10/RD	Clearances, creepage distances and distances through insulation		P
2.10.1/RD	General		P
2.10.1.1/RD	Frequency		P
2.10.1.2/RD	Pollution degrees	PD 3	P
2.10.1.3/RD	Reduced values for functional insulation		P
2.10.1.4/RD	Intervening unconnected conductive parts		N/A
2.10.1.5/RD	Insulation with varying dimensions		P
2.10.1.6/RD	Special separation requirements		P
2.10.1.7/RD	Insulation in circuits generating starting pulses		N/A
2.10.2/RD	Determination of working voltage	(See appended table 5.7)	P
2.10.2.1/RD	General		P
2.10.2.2/RD	RMS working voltage	600Vd.c.	P
2.10.2.3/RD	Peak working voltage	600Vd.c.	P
2.10.3/RD	Clearances		P
2.10.3.1/RD	General		P
2.10.3.2/RD	Mains transient voltages		P
	a) AC mains supply		P
	b) Earthed d.c. mains supplies		N/A
	c) Unearthed d.c. mains supplies		N/A
	d) Battery operation		P
2.10.3.3/RD	Clearances in primary circuits	(see appended table 5.7)	P
2.10.3.4/RD	Clearances in secondary circuits		N/A
2.10.3.5/RD	Clearances in circuits having starting pulses		N/A
2.10.3.6/RD	Transients from a.c. mains supply		N/A
2.10.3.7/RD	Transients from d.c. mains supply		N/A
2.10.3.8/RD	Transients from telecommunication networks and cable distribution systems		N/A
2.10.3.9/RD	Measurement of transient voltage levels		N/A
	a) Transients from a mains supply		N/A
	For an a.c. mains supply		N/A
	For a d.c. mains supply		N/A
	b) Transients from a telecommunication network		N/A



IEC 62040-1			
Clause	Requirement – Test	Result – Remark	Verdict
2.10.4/RD	Creepage distances	(see appended table 5.7)	N/A
2.10.4.1/RD	General		P
2.10.4.2/RD	Material group and comparative tracking index		P
	CTI tests	IIIa	—
2.10.4.3/RD	Minimum creepage distances		P
2.10.5 /RD	Solid insulation		P
2.10.5.1/RD	General		P
2.10.5.2/RD	Distances through insulation	(see appended table 5.7)	P
2.10.5.3/RD	Insulating compound as solid insulation		P
2.10.5.4/RD	Semiconductor devices	Approved optocoupler used	P
2.10.5.5/RD	Cemented joints		N/A
2.10.5.6/RD	Thin sheet material – General		P
2.10.5.7/RD	Separable thin sheet material		P
	Number of layers (pcs)	2 layers	—
2.10.5.8/RD	Non-separable thin sheet material		N/A
2.10.5.9/RD	Thin sheet material – standard test procedure		N/A
	Electric strength test		—
2.10.5.10 /RD	Thin sheet material – alternative test procedure		P
	Electric strength test	(see appended table 8.2)	—
2.10.5.11 /RD	Insulation in wound components		P
2.10.5.12 /RD	Wire in wound components		P
	Working voltage		—
	a) Basic insulation not under stress		P
	b) Basic, supplementary, reinforced insulation :		P
	c) Compliance with Annex U		P
	Two wires in contact inside wound component; angle between 45° and 90°		P
2.10.5.13 /RD	Wire with solvent-based enamel in wound components		P
	Electric strength test	(see appended table 8.2)	—
	Routine test		N/A
2.10.5.14 /RD	Additional insulation in wound components		N/A



IEC 62040-1			
Clause	Requirement – Test	Result – Remark	Verdict

	Working voltage		—
	- Basic insulation not under stress		N/A
	- Supplementary, reinforced insulation		N/A
2.10.6/RD	Construction of printed boards		P
2.10.6.1/RD	Uncoated printed boards		P
2.10.6.2/RD	Coated printed boards		N/A
2.10.6.3/RD	Insulation between conductors on the same inner surface of a printed board		P
2.10.6.4/RD	Insulation between conductors on different layers of a printed board		P
	Distance through insulation		P
	Number of insulation layers (pcs)		P
2.10.7/RD	Component external terminations		N/A
2.10.8/RD	Tests on coated printed boards and coated components		N/A
2.10.8.1/RD	Sample preparation and preliminary inspection		N/A
2.10.8.2/RD	Thermal conditioning		N/A
2.10.8.3/RD	Electric strength test		—
2.10.8.4/RD	Abrasion resistance test		N/A
2.10.9/RD	Thermal cycling		N/A
2.10.10/RD	Test for Pollution Degree 1 environment and insulating compound		N/A
2.10.11/RD	Tests for semiconductor devices and cemented joints		N/A
2.10.12/RD	Enclosed and sealed parts		N/A

6	Wiring, connections and supply		P
6.1	General		P
6.1.1	Introduction		P
3.1/RD	General		P
3.1.1/RD	Current rating and overcurrent protection		P
3.1.2/RD	Protection against mechanical damage		P
3.1.3/RD	Securing of internal wiring		P
3.1.4/RD	Insulation of conductors		P
3.1.5/RD	Beads and ceramic insulators		P
3.1.6/RD	Screws for electrical contact pressure		P



IEC 62040-1			
Clause	Requirement – Test	Result – Remark	Verdict

3.1.7/RD	Insulating materials in electrical connections		P
3.1.8/RD	Self-tapping and spaced thread screws		N/A
3.1.9/RD	Termination of conductors		P
	10 N pull test		P
3.1.10/RD	Sleeving on wiring		P
6.1.2	Dimensions and rating of busbars and insulated conductors		P

6.2	Connection to power		P
6.2.1	General provisions for connection to power		P
3.2.2/RD	Multiple supply connections		P
3.2.3/RD	Permanently connected equipment		P
	Number of conductors, diameter of cable and conduits (mm)		—
3.2.4/RD	Appliance inlets		N/A
3.2.5/RD	Power supply cords		N/A
3.2.5.1/RD	AC power supply cords		N/A
	Type		—
	Rated current (A), cross-sectional area (mm ²), AWG		—
3.2.5.2/RD	DC power supply cords		N/A
3.2.6/RD	Cord anchorages and strain relief		N/A
	Mass of equipment (kg), pull (N)		—
	Longitudinal displacement (mm)		—
3.2.7/RD	Protection against mechanical damage		P
3.2.8/RD	Cord guards		P
	Diameter or minor dimension D (mm); test mass (g)		—
	Radius of curvature of cord (mm).....		—
6.2.2	Means of connection	Permanent connection	P
	More than one supply connection		N/A

6.3	Wiring terminals for external power conductors		P
3.3/RD	Wiring terminals for connection of external conductors		P
3.3.1/RD	Wiring terminals		P



IEC 62040-1			
Clause	Requirement – Test	Result – Remark	Verdict

3.3.2/RD	Connection of non-detachable power supply cords		P
3.3.3/RD	Screw terminals		P
3.3.4/RD	Conductor sizes to be connected		P
	Rated current (A), cord/cable type, cross-sectional area (mm ²)..... :		—
3.3.5/RD	Wiring terminal sizes		P
	Rated current (A), type, nominal thread diameter (mm) :		—
3.3.6/RD	Wiring terminal design		P
3.3.7/RD	Grouping of wiring terminals		P
3.3.8/RD	Stranded wire		P

7	Physical requirements		P
7.1	Enclosure		P

7.2 4.1/RD	Stability		N/A
	Angle of 10°	Fixed equipment	N/A
	Test force (N) :		N/A

7.3 4.2/RD	Mechanical strength		P
4.2.1/RD	General		P
4.2.2/RD	Steady force test, 10 N		—
4.2.3/RD	Steady force test, 30 N		N/A
4.2.4/RD	Steady force test, 250 N		P
4.2.5/RD	Impact test		P
	Fall test		P
	Swing test		N/A
4.2.6/RD	Drop test; height (mm) :		N/A
4.2.7/RD	Stress relief test		—
4.2.8/RD	Cathode ray tubes		N/A
	Picture tube separately certified :		—
4.2.9/RD	High pressure lamps		N/A
4.2.10/RD	Wall or ceiling mounted equipment; force (N) . :	630N	P



IEC 62040-1			
Clause	Requirement – Test	Result – Remark	Verdict

7.4	Construction details		P
7.4.1	Introduction		P
4.3.1/RD	Edges and corners		P
4.3.2/RD	Handles and manual controls; force (N)..... :		N/A
4.3.3/RD	Adjustable controls		N/A
4.3.4/RD	Securing of parts		N/A
4.3.5/RD	Connection by plugs and sockets		N/A
4.3.7/RD	Heating elements in earthed equipment		N/A
4.3.11/RD	Containers for liquids or gases		N/A
4.4/RD	Protection against hazardous moving parts		P
4.4.1/RD	General		P
4.4.2/RD	Protection in operator access areas :		N/A
4.4.3/RD	Protection in restricted access locations :		P
4.4.4/RD	Protection in service access areas		N/A
4.5/RD	Thermal requirements		P
4.5.1/RD	General		P
4.5.2/RD	Temperature tests		P
	Normal load condition per Annex L :		P
4.5.3/RD	Temperature limits for materials		P
4.5.4/RD	Touch temperature limits		P
4.5.5/RD	Resistance to abnormal heat : (see appended table 7.4)		P
7.4.2	Openings		P
7.4.3	Gas Concentration		P
7.4.4	Equipment movement		N/A

7.5	Resistance to fire		P
4.7/RD			
4.7.1/RD	Reducing the risk of ignition and spread of flame		P
	Method 1, selection and application of components wiring and materials		P
	Method 2, application of all of simulated fault condition tests		N/A
4.7.2/RD	Conditions for a fire enclosure		P
4.7.2.1/RD	Parts requiring a fire enclosure		P



IEC 62040-1			
Clause	Requirement – Test	Result – Remark	Verdict

4.7.2.2/RD	Parts not requiring a fire enclosure		P
4.7.3/RD	Materials	Metal enclosure	P
4.7.3.1/RD	General		P
4.7.3.2/RD	Materials for fire enclosures		P
4.7.3.3/RD	Materials for components and other parts outside fire enclosures		P
4.7.3.4/RD	Materials for components and other parts inside fire enclosures		P
4.7.3.5/RD	Materials for air filter assemblies		N/A
4.7.3.6/RD	Materials used in high-voltage components		N/A

7.6	Battery location		N/A
7.6.1	Battery location and installation	Certified lithium battery of external battery pack (EBP).will be used in final installation not included in UPS. The explanations are provided in the manufacturer's EBP of manual.	N/A
7.6.2	Accessibility and maintainability	See above.	N/A
7.6.3	Distance	See above.	N/A
7.6.4	Case insulation	See above.	N/A
7.6.5	Wiring	See above.	N/A
7.6.6	Electrolyte spillage	See above.	N/A
7.6.7	Ventilation	See above.	N/A
7.6.8	Charging voltage	See above.	N/A

7.7	Temperature rise		P
4.5/RD	Thermal requirements		P
4.5.1/RD	General		P
4.5.2/RD	Temperature tests	(see appended table 7.7)	P
	Normal load condition per Annex L :		P
4.5.3/RD	Temperature limits for materials		P
4.5.4/RD	Touch temperature limits		P
4.5.5/RD	Resistance to abnormal heat :		P

8	Electrical requirements and simulated abnormal conditions		P
---	---	--	---



IEC 62040-1			
Clause	Requirement – Test	Result – Remark	Verdict

8.1	General provisions for earth leakage		P
5.1.1/RD	General	Living part and com. Port: 0.16 mA Live part and metal enclosure: 2.05mA	P
5.1.7/RD	Equipment with touch current exceeding 3,5 mA		N/A

8.2 5.2/RD	Electric strength		P
5.2.1/RD	General	(see appended table 8.2)	P
5.2.2/RD	Test procedure	(see appended table 8.2)	P

8.3	Abnormal operating and fault conditions		P
8.3.1	General		P
5.3.1/RD	Protection against overload and abnormal operation	(see appended table 8.3)	P
5.3.2/RD	Motors		N/A
5.3.3/RD	Transformers	(see appended Annex C)	P
5.3.4/RD	Functional insulation..... :		P
5.3.5/RD	Electromechanical components		P
5.3.9/RD	Compliance criteria for abnormal operating and fault conditions		P
8.3.2	Simulation of faults		P
8.3.3	Conditions for tests		P

9 6/RD	Connection to telecommunication networks		N/A
6.1/RD	Protection of telecommunication network service persons, and users of other equipment connected to the network, from hazards in the equipment		N/A
6.1.1/RD	Protection from hazardous voltages		N/A
6.1.2/RD	Separation of the telecommunication network from earth		N/A
6.1.2.1/RD	Requirements		N/A
	Supply voltage (V)		—
	Current in the test circuit (mA)		—
6.1.2.2/RD	Exclusions		N/A
6.2/RD	Protection of equipment users from overvoltages on telecommunication networks		N/A



IEC 62040-1			
Clause	Requirement – Test	Result – Remark	Verdict
6.2.1/RD	Separation requirements		N/A
6.2.2/RD	Electric strength test procedure		N/A
6.2.2.1/RD	Impulse test		N/A
6.2.2.2/RD	Steady-state test		N/A
6.2.2.3/RD	Compliance criteria		N/A
6.3/RD	Protection of the telecommunication wiring system from overheating		N/A
	Max. output current (A)		—
3.5/RD	Interconnection of equipment		N/A
3.5.1/RD	General requirements		N/A
3.5.2/RD	Types of interconnection circuits		N/A
3.5.3/RD	ELV circuits as interconnection circuits		N/A
3.5.4/RD	Data ports for additional equipment		N/A
2.1.3/RD	Protection in restricted access locations		N/A
2.3.1/RD	Limits		N/A
	Type of TNV circuits		—
2.3.2/RD	Separation from other circuits and from accessible parts		N/A
2.3.2.1/RD	General requirements		N/A
2.3.2.2/RD	Protection by basic insulation		N/A
2.3.2.3/RD	Protection by earthing		N/A
2.3.2.4/RD	Protection by other constructions		N/A
2.3.3/RD	Separation from hazardous voltages		N/A
	Insulation employed.....		—
2.3.4/RD	Connection of TNV circuits to other circuits		N/A
	Insulation employed.....		—
2.3.5/RD	Test for operating voltages generated externally		N/A
2.6.5.8/RD	Reliance on telecommunication network or cable distribution system		N/A
2.10.3.3/RD	Clearances in primary circuits		N/A
2.10.3.4/RD	Clearances in secondary circuits		N/A
2.10.4/RD	Creepage distances		N/A
2.10.4.1/RD	General		N/A
2.10.4.2/RD	Material group and comparative tracking index		N/A
	CTI tests		—
2.10.4.3/RD	Minimum creepage distances		N/A



IEC 62040-1			
Clause	Requirement – Test	Result – Remark	Verdict

M/RD	ANNEX M, CRITERIA FOR TELEPHONE RINGING SIGNALS (see 2.3.1/RD)		N/A
M.1/RD	Introduction		N/A
M.2 /RD	Method A		N/A
M.3/RD	Method B		N/A
M.3.1/RD	Ringing signal		N/A
M.3.1.1/RD	Frequency (Hz)		—
M.3.1.2/RD	Voltage (V)		—
M.3.1.3/RD	Cadence; time (s), voltage (V)		—
M.3.1.4/RD	Single fault current (mA)		—
M.3.2/RD	Tripping device and monitoring voltage		N/A
M.3.2.1/RD	Conditions for use of a tripping device or a monitoring voltage		—
M.3.2.2/RD	Tripping device		N/A
M.3.2.3/RD	Monitoring voltage (V)		N/A

A/RD	Annex A, Tests for resistance to heat and fire		N/A
A.1/RD	Flammability test for fire enclosures of movable equipment having a total mass exceeding 18 kg, and of stationary equipment (see 4.7.3.2/RD)		N/A
A.1.1/RD	Samples.....		—
	Wall thickness (mm).....		—
A.1.2/RD	Conditioning of samples; temperature (°C)		N/A
A.1.3/RD	Mounting of samples		N/A
A.1.4/RD	Test flame (see IEC 60695-11-3)		N/A
	Flame A, B, C or D		—
A.1.5/RD	Test procedure		N/A
A.1.6/RD	Compliance criteria		N/A
	Sample 1 burning time (s)		—
	Sample 2 burning time (s)		—
	Sample 3 burning time (s)		—
A.2/RD	Flammability test for fire enclosures of movable equipment having a total mass not exceeding 18 kg, and for material and components located inside fire enclosures (see 4.7.3.2/RD and 4.7.3.4/RD)		N/A
A.2.1/RD	Samples, material.....		—
	Wall thickness (mm).....		—



IEC 62040-1			
Clause	Requirement – Test	Result – Remark	Verdict
A.2.2/RD	Conditioning of samples; temperature (°C) :		N/A
A.2.3/RD	Mounting of samples :		N/A
A.2.4/RD	Test flame (see IEC 60695-11-4)		N/A
	Flame A, B or C :		—
A.2.5/RD	Test procedure		N/A
A.2.6/RD	Compliance criteria		N/A
	Sample 1 burning time (s) :		—
	Sample 2 burning time (s) :		—
	Sample 3 burning time (s) :		—
A.2.7/RD	Alternative test acc. to IEC 60695-11-5, cl. 5 and 9		N/A
	Sample 1 burning time (s) :		—
	Sample 2 burning time (s) :		—
	Sample 3 burning time (s) :		—
A.3/RD	Hot flaming oil test (see 4.6.2/RD)		N/A
A.3.1/RD	Mounting of samples		N/A
A.3.2/RD	Test procedure		N/A
A.3.3/RD	Compliance criterion		N/A

B/RD	Annex B, Motor tests under abnormal conditions (see 4.7.2.2/RD and 5.3.2/RD)		N/A
B.1/RD	General requirements		N/A
	Position :		—
	Manufacturer :		—
	Type :		—
	Rated values :		—
B.2/RD	Test conditions		N/A
B.3/RD	Maximum temperatures		N/A
B.4/RD	Running overload test		N/A
B.5/RD	Locked-rotor overload test		N/A
	Test duration (days) :		—
	Electric strength test: test voltage (V) :		—
B.6/RD	Running overload test for d.c. motors in secondary circuits		N/A
B.6.1/RD	General		N/A



IEC 62040-1			
Clause	Requirement – Test	Result – Remark	Verdict
B.6.2/RD	Test procedure		N/A
B.6.3/RD	Alternative test procedure		N/A
B.6.4/RD	Electric strength test; test voltage (V)		N/A
B.7/RD	Locked-rotor overload test for d.c. motors in secondary circuits		N/A
B.7.1/RD	General		N/A
B.7.2/RD	Test procedure		N/A
B.7.3/RD	Alternative test procedure		N/A
B.7.4/RD	Electric strength test; test voltage (V)		N/A
B.8/RD	Test for motors with capacitors		N/A
B.9/RD	Test for three-phase motors		N/A
B.10/RD	Test for series motors		N/A
	Operating voltage (V)		—
C/RD	Annex C, Transformers (see 1.5.4/RD and 5.3.3/RD)		N/A
	Position	Transformerless type inverter	—
	Manufacturer		—
	Type		—
	Rated values		—
	Method of protection.....		—
C.1/RD	Overload test		N/A
C.2/RD	Insulation		N/A
	Protection from displacement of windings.....		N/A
D/RD	Annex D, Measuring instruments for touch current tests (see 5.1.4/RD)		P
D.1/RD	Measuring instrument		P
D.2/RD	Alternative measuring instrument		N/A
E/RD	Annex E, Temperature rise of a winding (see 1.4.13/RD)		P
F/RD	Annex F, Measurements of clearances and creepage distance (see 2.10/RD and Annex G/RD)		P
G/RD	Annex G, Alternative method for determining minimum clearances		N/A



IEC 62040-1			
Clause	Requirement – Test	Result – Remark	Verdict

G.1/RD	Clearances		N/A
G.1.1/RD	General		N/A
G.1.2/RD	Summary of the procedure for determining minimum clearances		N/A
G.2/RD	Determination of mains transient voltage (V)		N/A
G.2.1/RD	AC mains supply		N/A
G.2.2/RD	Earthed d.c. mains supplies		N/A
G.2.3/RD	Unearthed d.c. mains supplies		N/A
G.2.4/RD	Battery operation		N/A
G.3/RD	Determination of telecommunication network transient voltage (V)		N/A
G.4/RD	Determination of required withstand voltage (V)		N/A
G.4.1/RD	Mains transients and internal repetitive peaks :		N/A
G.4.2/RD	Transients from telecommunication networks . :		N/A
G.4.3/RD	Combination of transients		N/A
G.4.4/RD	Transients from cable distribution systems		N/A
G.5/RD	Measurement of transient voltages (V)		N/A
	a) Transients from a mains supply		N/A
	For an a.c. mains supply		N/A
	For a d.c. mains supply		N/A
	b) Transients from a telecommunication network		N/A
G.6/RD	Determination of minimum clearances		N/A

H	Annex H, Guidance on protection against ingress of water and foreign objects (see IEC 60529)		N/A
---	--	--	-----

I	Annex I, Backfeed protection test		N/A
I.1	General		N/A
I.2	Test for pluggable UPS		N/A
I.3	Test for permanently connected UPS		N/A
I.4	Load-induced change of reference potential		N/A
I.5	Solid-state backfeed protection (see clause 7.1-7.5 of IEC 62040-2 and clause 7.1-7.2 of IEC 62040-3)		N/A

J/RD	Annex J, Table of electrochemical potentials (see 2.6.5.6/RD)		N/A
------	---	--	-----



IEC 62040-1			
Clause	Requirement – Test	Result – Remark	Verdict

	Metal(s) used		—
--	---------------------	--	---

K/RD	Annex K, Thermal controls (see 1.5.3/RD and 5.3.8/RD)		N/A
K.1/RD	Making and breaking capacity		N/A
K.2 /RD	Thermostat reliability; operating voltage (V) :		N/A
K.3/RD	Thermostat endurance test; operating voltage (V)		N/A
K.4/RD	Temperature limiter endurance; operating voltage (V)		N/A
K.5/RD	Thermal cut-out reliability		N/A
K.6/RD	Stability of operation		N/A

L	Annex L, Reference loads		P
L.1	General		P
L.2	Reference resistive load		P
L.3	Reference inductive-resistive load		—
L.4	Reference capacitive-resistive loads		N/A
L.5	Reference non-linear load		N/A
L.5.1	Test method		N/A
L.5.2	Connection of the non-linear reference load		—

M	Annex M, Ventilation of battery compartments		N/A
M.1	General	External battery provide	N/A
M.2	Normal conditions		N/A
M.3	Blocked conditions		N/A
M.4	Overcharge conditions		N/A

N	Annex N, Minimum and maximum cross-sections of copper conductors suitable for connection (see 6.3)		P
---	--	--	---

U/RD	Annex U, Insulated winding wires for use without interleaved insulation (see 2.10.5.4/RD)		P
			—

V/RD	Annex V, AC POWER DISTRIBUTION SYSTEMS (see 1.6.1/RD)		P
------	---	--	---



BUREAU
VERITAS

Test Report No.: LD190808N030-1

IEC 62040-1			
Clause	Requirement – Test	Result – Remark	Verdict
V.1/RD	Introduction		P
V.2/RD	TN power distribution systems		P



IEC 62040-1			
Clause	Requirement – Test	Result – Remark	Verdict

4.5	TABLE: list of critical components					P
object/part No.	manufacturer/ trademark	type/model	technical data	standard	mark(s) of conformity!	
Metal Enclosure	Rechangeable	Rechangeable	Min. thickness : 1.2mm	--	--	
Heat-sink (the rear side of enclosure)	Rechangeable	Rechangeable	Metal, overall measured: L: 445mm, W: 340mm, H: 57.5mm	--	--	
DC breaker	Santon	XBE3310-2-D	650V dc, 25A dc, Max.70°C	EN 60947- 3/A1/C1	DEKRA: 2199573.01	
Or	ProJoy Electric SRL.	PEDS150R- HM25-3	25A, 600VDC, Max.75°C	EN 60947- 3:2009+A1	TUV R50389807	
PV connector	Amphenol Industrial operations	Helios H4 series	1000Vdc, 40A, Max. 90°C, IP68	DIN V VDE V 0126-3/12.2006	TUV R 50157783	
Or	PV-FT-CF-C; PV-FT-CM-C	Phoenix Contact GmbH & Co.kg	1000Vdc, 40A, Max.85°C, IP65	EN 50521:2008	TUV R 60029159	
Or	MC4 Series	Stäubli Electrical Connectors Ltd.	1000Vdc, 39A, Max. 90°C, IP68	EN 50521:2008	TUV R 60028286 R 60087448	
Or	H4-RH Bulkhead	Amphenol Technology Co., Ltd	1000Vdc, 39A, Max. 90°C, IP68	EN 50521	TUV 17011847012	
Battery terminal	SHENZHEN SUCCEED ELECTRONICS TECHNOLOGY CO.,LTD	TR100-01-2P	AC600V, 100A, Max. 120°C	UL 1059, UL 486E	UL E332956	
Internal wiring (DC-in)	Rechangeable	Rechangeable	Min.8AWG,600 V,105°C,VW-1	UL 758	UL	
Internal wiring (AC-out)	Rechangeable	Rechangeable	Min.12AWG,60 0V,105°C,VW-1	UL 758	UL	
Earthing wire	Rechangeable	Rechangeable	Min. 12AWG, 600V, 105°C, VW-1	UL 1015	UL	
Battery wire	Rechangeable	Rechangeable	Min.8AWG, 600V, 105°C, VW-1	UL 1015	UL	



AC Grid terminal	SHENZHEN SUCCEED ELECTRONICS TECHNOLOGY CO.,LTD	TR-6N-01-NP - XX-T(f)	600V, 50A, Max. 105°C	UL 1059, UL 486E	UL E332956
Plastic sheet for Transistors	BERGQUIST CO	K-10#	150°C, VTM-0, min. 0.13mm thickness	UL 94	UL E59150
All PCB	Rechargeable	Rechargeable	Min.130°C, min. V-0, CTI≥175	UL 796	UL
LCD panel	MACDERMID AUTOTYPE LTD	Autotex XE(f2)	105°C, V-0, min. 0.2mm thickness	UL 94 UL 746C	UL E165805
Boost inductor (L1, L2)	Huizhou Baohui Electronics Technology Co., Ltd	SH-L1,2,3	0.84mH, Class B	--	--
- Lead wire	Rechargeable	Rechargeable	10AWG, 600V, 105°C, VW-1	UL 758	UL
Inductor (L4, L5, TX1)	Huizhou Baohui Electronics Technology Co., Ltd	SH-T016	840μH, ClassB	--	--
- Lead wire	Rechargeable	Rechargeable	10AWG, 600V, 105°C, VW-1	UL 758	UL
Inductor (L8, L9, L14, L15)	Huizhou Baohui Electronics Technology Co., Ltd	SH-L040	0.5mH, ClassB	--	--
-Winding	Rechargeable	Rechargeable	155°C	UL 1446	UL
-Expoxy	DONGGUAN EATTO ELECTRONIC MATERIAL CO LTD	3300A-1/B-1	V-0, 130°C	UL 746 UL94	UL E218090
SPS transformer (T1)	Huizhou Baohui Electronics Technology Co., Ltd	SH-T008	Class B	--	--
-Winding	Rechargeable	Rechargeable	130°C	UL 1446	UL
--Tape	JINGJIANG YAHUA PRESSURE SENSITIVE GLUE CO LTD	CT-	130°C	UL 510	UL E165111
- Margin Tape	Jingjiang Yahua Pressure Sensitive Glue Co Ltd	WF-	130°C	UL 510	UL E165111



-Expoxy	DONGGUAN EATTO ELECTRONIC MATERIAL CO LTD	3300A-1/B-1	V-0, 130°C	UL 746 UL94	UL E218090
Transformer (TX2,T3)	Huizhou Baohui Electronics Technology Co., Ltd	SH-T010	Class B	--	--
-Winding	All	All accepted	130°C	UL 1446	UL
- Bobbin	CHANG CHUN PLASTICS CO LTD	PM-9820 PM-9830	V-0, min. thickness: 0.75mm, 150°C	UL 94	UL E41429
- Margin Tape	Jingjiang Yahua Pressure Sensitive Glue Co Ltd	CT-	130°C	UL 510	UL E165111
BUS Capacitor (C1, C2, C3, C4, C7, C8, C9, C10)	Unielecs Co.,LTD	LLN2F102M355 0	1000µf, 315V, Max.105°C	--	--
Or	Nichicon Co., Ltd.	LGX2F102MEL EZS	1000µf, 315V, Max.105°C	--	--
Or	Nantong jianghai Capacitor Co., Ltd.	ECS2FBB102M VN350050V	1000µf, 315V, Max.105°C	--	--
Or	LELON ELECTRONICS CORP.	LSK102M2F-- A3550	1000µf, 315V, Max.105°C	--	--
DC-LINK Capacitor (C13)	Xiamen FARA Electronic Co.,Ltd	C3D2H606KF0 AC00	60µF, 500V, 105°C	EN61071:2007; EN61881- 1:2011	TUV R 50266108
Y capacitor (C30,C31,C337)	Shantou High- New Technology Dev. Zone Songtian Enterprise Co., Ltd	CE	10nF, 250Vac, Max.125°C	EN 60384- 14:2013; IEC 60384-14(ed.4)	VDE 40025748



Y capacitor (C20,C92,C97, C104,C105,C10 6,C113,C114,C 115,C132,C134, C137,C138,C14 1,C142,C147,C 148)	Shantou High- New Technology Dev. Zone Songtian Enterprise Co., Ltd	CD	Y1, 4.7nF, 400Vac, Max.125°C	EN 60384- 14:2013; IEC 60384-14(ed.4)	VDE 40025754
X2 capacitor (C103,C112)	Shantou High- New Technology Dev. Zone Songtian Enterprise Co., Ltd	MPX	1μF, 275V, Max.110 °C	EN 60384- 14:2013; IEC 60384-14(ed.4)	VDE 40034679
Current transducer (HL1)	LEM	CASR 25-NP	IPN: ±25A; V _{out} : ±5V Max.: 85°C	--	--
IGBT (Q1, Q2, Q3, Q4, Q5, Q6, Q7, Q12, Q25, Q26)	Fairchild Semiconductor Corporation	FGA40N65SMD	650V, 40A, 155°C	--	--
Or	Fairchild Semiconductor Corporation	FGA60N65SMD	650V, 60A, 155°C	--	--
Or	ST Microelectronics	STGWT40H65 DFB	650V, 40A, 155°C	--	--
Or	IXYS CORPORATIO N	IXXH40N65B4H 1	650V, 40A, 155°C	--	--
Or	ST Semiconductor Corporation	STGWT60H65 DFB	650V, 60A, Max.150°C	--	--
IGBT (QD1, QD2, QD3, QD4)	Infineon Semiconductor Corporation	IKW40N65H5	650V, 46A, 155°C	--	--
MOSFET (Q16, Q17, Q18, Q19, Q21, Q22, Q23, Q24)	Fairchild Semiconductor Corporation	FDP027N08B	80V, 120A, 175°C	--	--
Or	ST Microelectronics	STP270N8F7	80V, 180A, 155°C	--	--
Doide (D13, D12)	IXYS CORPORATIO N	DSEI30-06A	37A, 600V, , 155°C	--	--
Or	MICROSEMI CORPORATIO N	APT30DQ60BG	30A, 600V, , 155°C	--	--



Relay (RL1 , RL2 , RL3 , RL4 , RL5 , RL6	Xiamen Hongfa Electroacoustics Co., Ltd.	HF161F-W/12- HT	31A, 250Vac, 12Vdc, 85°C	IEC/EN 61810-1	VDE 40031410
Or	ALFG2PF121	33A,277VAC,12 VDC, Max.85°C	Panasonic Corporation	VDE 0435	VDE 40023067
Optocoupler (U14,U15,U16,U 17,U19,U20)	Liteon optoelectronics	LTV816	Di \geq 0.4mm, Internall di \geq 7.0mm, External di \geq 7.62mm, AC 8000V, 115°C	IEC 60747-5-5	VDE 40015248
Optocoupler U2,U3,U13,U14, U17,U18,U26,U 27,U31,U32	TOSHIBA Semiconductor Corporation	TLP350 (D4- TP1.F)	Di \geq 0.4mm Internal di \geq 7.0mm External di \geq 7.0mm, AC 5000V, reinforced Insulation 100°C	DIN EN 60747- 5-2	VDE 40009302
Or	TOSHIBA	TLP352(TP1,F)	Di \geq 0.4mm Internall di \geq 7.0mm External di \geq 7.0mm, 125°C	DIN EN 60747- 5-2	VDE 40009302
GFCI (L10)	Huizhou Baohui Electronics Technology Co., Ltd	W539	Class B	--	--
-Expoxy	DONGGUAN EATTO ELECTRONIC MATERIAL CO LTD	3300A-1/B-1	V-0, 130°C	UL 746 UL94	UL E218090
Or	HUI ZHOU QIANG DA ELECTRONICS INDUSTRY CO LTD	QDJ600(#)	V-0, 130°C	UL 746 UL94	UL E351561



-Tape	SHENZHEN WOER HEAT- SHRINKABLE MATERIAL CO LTD	WF	200°C	UL224	UL 203950
-------	--	----	-------	-------	-----------

1) an asterisk indicates a mark which assures the agreed level of surveillance

4.6, 1.62/RD	TABLE: electrical data (in normal conditions)						P
Type	U (V)	I (A) DC	P (W) DC	U (V)	I (A) AC	P (W) AC	
PV Input mode							
HYD 6000-ES	90Vdc	7.223	646	230V/50Hz	2.936	590	
HYD 6000-ES	300Vdc	20.739	6225	230V/50Hz	25.789	5954	
HYD 6000-ES	360Vdc	17.274	6169	230V/50Hz	25.824	5961	
HYD 6000-ES	520Vdc	12.096	6234	230V/50Hz	26.208	6014	
HYD 6000-ES	580Vdc	0.528	299	230V/50Hz	1.721	265	
HYD 6000-ES	90Vdc	7.087	645	230V/60Hz	2.981	590	
HYD 6000-ES	300Vdc	20.653	6209	230V/60Hz	25.732	5932	
HYD 6000-ES	360Vdc	17.112	6131	230V/60Hz	25.66	5926	
HYD 6000-ES	520Vdc	12.020	6206	230V/60Hz	26.091	5991	
HYD 6000-ES	580Vdc	0.529	301	230V/60Hz	1.830	285	
Type	U (V)	I (A) DC	P (W) DC	U (V)	I (A) DC	P (W) DC	
PV charging mode							
HYD 6000-ES	90Vdc	7.225	647	46Vdc	11.804	543	
HYD 6000-ES	300Vdc	10.646	3208	46Vdc	64.989	2985	
HYD 6000-ES	360Vdc	8.858	3174	46Vdc	64.981	2990	
HYD 6000-ES	520Vdc	6.155	3197	46Vdc	64.964	2987	
HYD 6000-ES	580Vdc	0.519	299	46Vdc	5.132	236	
HYD 6000-ES	90Vdc	7.165	646	48Vdc	11.409	548	
HYD 6000-ES	300Vdc	10.740	3212	48Vdc	62.78	3011	
HYD 6000-ES	360Vdc	8.936	3214	48Vdc	63.000	3023	
HYD 6000-ES	520Vdc	6.179	3215	48Vdc	62.799	3011	
HYD 6000-ES	580Vdc	0.519	297	48Vdc	4.904	235	
HYD 6000-ES	90Vdc	7.223	647	58Vdc	9.256	539	
HYD 6000-ES	300Vdc	10.619	3191	58Vdc	51.439	2993	
HYD 6000-ES	360Vdc	8.907	3214	58Vdc	51.856	3017	
HYD 6000-ES	520Vdc	6.201	3217	58Vdc	52.320	3042	
HYD 6000-ES	580Vdc	0.515	297	58Vdc	4.029	234	
Type	U (V)	I (A) AC	P (W) AC	U (V)	I (A) DC	P (W) DC	
AC charging mode							
HYD 6000-ES	207Vac	15.712	3241	46Vdc	64.924	2976	
HYD 6000-ES	230Vac	14.110	3234	46Vdc	64.904	2978	
HYD 6000-ES	253Vac	12.847	3230	46Vdc	64.921	2979	
HYD 6000-ES	207Vac	16.001	3296	48Vdc	63.006	3033	
HYD 6000-ES	230Vac	14.348	3285	48Vdc	63.014	3034	
HYD 6000-ES	253Vac	13.053	3279	48Vdc	63.031	3035	
HYD 6000-ES	207Vac	15.948	3277	58Vdc	52.073	3032	
HYD 6000-ES	230Vac	14.280	3261	58Vdc	52.064	3032	
HYD 6000-ES	253Vac	12.931	3248	58Vdc	52.044	3030	
Type	U (V)	I (A) DC	P (W) DC	U (V)	I (A) AC	P (W) AC	
Battery discharging mode							



HYD 6000-ES	46Vdc	69.977	3221	207Vac/50Hz	14.851	2989
HYD 6000-ES	46Vdc	69.945	3219	230Vac/50Hz	13.459	2992
HYD 6000-ES	46Vdc	69.948	3220	253Vac/50Hz	12.279	2990
HYD 6000-ES	48Vdc	66.861	3224	207Vac/50Hz	14.851	2995
HYD 6000-ES	48Vdc	66.998	3222	230Vac/50Hz	13.447	2998
HYD 6000-ES	48Vdc	66.974	3222	253Vac/50Hz	12.305	2996
HYD 6000-ES	58Vdc	56.462	3245	207Vac/50Hz	15.013	3011
HYD 6000-ES	58Vdc	56.415	3245	230Vac/50Hz	13.990	3019
HYD 6000-ES	58Vdc	56.426	3244	253Vac/50Hz	12.403	3024
HYD 6000-ES	46Vdc	69.969	3220	207Vac/60Hz	14.849	2989
HYD 6000-ES	46Vdc	69.951	3222	230Vac/60Hz	14.851	2989
HYD 6000-ES	46Vdc	69.951	3220	253Vac/60Hz	12.281	2991
HYD 6000-ES	48Vdc	66.859	3224	207Vac/60Hz	14.848	2995
HYD 6000-ES	48Vdc	66.995	3222	230Vac/60Hz	13.449	2998
HYD 6000-ES	48Vdc	66.969	3221	253Vac/60Hz	12.302	2996
HYD 6000-ES	58Vdc	56.459	3244	207Vac/60Hz	15.009	3010
HYD 6000-ES	58Vdc	56.409	3245	230Vac/60Hz	14.003	3019
HYD 6000-ES	58Vdc	56.431	3243	253Vac/60Hz	12.411	3023
Type	U (V)	I (A) DC	P (W) DC	U (V)	I (A) AC	P (W) AC
PV input for battery charging and AC output mode						
HYD 6000-ES	90Vdc	7.208	646	230Vac/50Hz	0.010	2
HYD 6000-ES				46Vdc	11.891	548
HYD 6000-ES	300Vdc	20.66	6212	230Vac/50Hz	12.615	2880
HYD 6000-ES				46Vdc	64.941	2989
HYD 6000-ES	360Vdc	17.376	6216	230Vac/50Hz	12.911	2954
HYD 6000-ES				46Vdc	64.970	2990
HYD 6000-ES	520Vdc	12.029	6231	230Vac/50Hz	13.014	2956
HYD 6000-ES				46Vdc	64.986	2988
HYD 6000-ES	580Vdc	0.519	298	230Vac/50Hz	0.015	2
HYD 6000-ES				46Vdc	5.133	236
HYD 6000-ES	90Vdc	7.199	646	230Vac/50Hz	0.010	1
HYD 6000-ES				48Vdc	11.496	549
HYD 6000-ES	300Vdc	20.738	6214	230Vac/50Hz	12.676	2895
HYD 6000-ES				48Vdc	62.402	2995
HYD 6000-ES	360Vdc	17.291	6225	230Vac/50Hz	12.749	2911
HYD 6000-ES				48Vdc	62.464	2997
HYD 6000-ES	520Vdc	12.024	6232	230Vac/50Hz	12.830	2909
HYD 6000-ES				48Vdc	63.358	3037
HYD 6000-ES	580Vdc	0.520	299	230Vac/50Hz	0.010	1
HYD 6000-ES				48Vdc	4.924	236
HYD 6000-ES	90Vdc	7.151	646	230Vac/50Hz	0.010	1
HYD 6000-ES				58Vdc	9.396	548
HYD 6000-ES	300Vdc	20.776	6216	230Vac/50Hz	12.708	2899
HYD 6000-ES				58Vdc	51.45	2999
HYD 6000-ES	360Vdc	17.318	6226	230Vac/50Hz	12.883	2936
HYD 6000-ES				58Vdc	51.388	2995
HYD 6000-ES	520Vdc	12.035	6230	230Vac/50Hz	13.158	2990
HYD 6000-ES				58Vdc	51.379	2992
HYD 6000-ES	580Vdc	0.515	297	230Vac/50Hz	0.010	1
HYD 6000-ES				58Vdc	3.950	230
HYD 6000-ES	90Vdc	7.227	647	230Vac/60Hz	0.011	2
HYD 6000-ES				46Vdc	11.886	548
HYD 6000-ES	300Vdc	20.659	6212	230Vac/60Hz	12.610	2879



HYD 6000-ES				46Vdc	64.935	2989
HYD 6000-ES	360Vdc	17.206	6209	230Vac/60Hz	12.876	2947
HYD 6000-ES				46Vdc	64.953	2989
HYD 6000-ES	520Vdc	12.028	6231	230Vac/60Hz	13.030	2954
HYD 6000-ES				46Vdc	64.333	2987
HYD 6000-ES	580Vdc	0.518	298	230Vac/60Hz	0.015	2
HYD 6000-ES				46Vdc	5.132	237
HYD 6000-ES	90Vdc	7.135	644	230Vac/60Hz	0.012	2
HYD 6000-ES				48Vdc	11.491	554
HYD 6000-ES	300Vdc	20.738	6215	230Vac/60Hz	12.644	2890
HYD 6000-ES				48Vdc	62.383	2994
HYD 6000-ES	360Vdc	17.292	6225	230Vac/60Hz	12.747	2914
HYD 6000-ES				48Vdc	62.467	2997
HYD 6000-ES	520Vdc	12.024	6232	230Vac/60Hz	12.825	2909
HYD 6000-ES				48Vdc	63.353	3037
HYD 6000-ES	580Vdc	0.518	298	230Vac/60Hz	0.010	1
HYD 6000-ES				48Vdc	4.929	237
HYD 6000-ES	90Vdc	7.188	646	230Vac/60Hz	0.010	1
HYD 6000-ES				58Vdc	9.396	549
HYD 6000-ES	300Vdc	20.778	6216	230Vac/60Hz	12.708	2899
HYD 6000-ES				58Vdc	51.444	2999
HYD 6000-ES	360Vdc	17.319	6226	230Vac/60Hz	12.865	2935
HYD 6000-ES				58Vdc	51.367	2993
HYD 6000-ES	520Vdc	12.031	6231	230Vac/60Hz	13.176	2990
HYD 6000-ES				58Vdc	51.362	2991
HYD 6000-ES	580Vdc	0.518	299	230Vac/60Hz	0.015	3
HYD 6000-ES				58Vdc	3.947	230

supplementary information

4.6, 1.62/RD	TABLE: electrical data (in normal conditions)						P
Type	U (V)	I (A) DC	P (W) DC	U (V)	I (A) AC	P (W) AC	
PV Input mode							
HYD 5000-ES	90Vdc	8.761	793	230V/50Hz	3.489	730	
HYD 5000-ES	250Vdc	20.791	5192	230V/50Hz	21.532	4957	
HYD 5000-ES	360Vdc	14.296	5106	230V/50Hz	21.451	4941	
HYD 5000-ES	520Vdc	10.031	5173	230V/50Hz	21.847	4996	
HYD 5000-ES	580Vdc	0.485	277	230V/50Hz	1.074	247	
HYD 5000-ES	90Vdc	9.225	823	230V/60Hz	3.645	758	
HYD 5000-ES	250Vdc	20.803	5210	230V/60Hz	21.595	4965	
HYD 5000-ES	360Vdc	14.316	5114	230V/60Hz	21.484	4948	
HYD 5000-ES	520Vdc	10.152	5235	230V/60Hz	22.076	5049	
HYD 5000-ES	580Vdc	0.493	285	230V/60Hz	1.109	255	
Type	U (V)	I (A) DC	P (W) DC	U (V)	I (A) DC	P (W) DC	
PV charging mode							
HYD 5000-ES	90Vdc	9.005	793	46Vdc	15.368	705	
HYD 5000-ES	250Vdc	12.896	3187	46Vdc	64.253	2945	
HYD 5000-ES	360Vdc	8.863	3194	46Vdc	65.352	2994	
HYD 5000-ES	520Vdc	6.161	3197	46Vdc	65.158	2982	
HYD 5000-ES	580Vdc	0.480	277	46Vdc	4.725	217	
HYD 5000-ES	90Vdc	8.763	792	48Vdc	14.422	696	
HYD 5000-ES	250Vdc	12.759	3188	48Vdc	61.287	2954	



HYD 5000-ES	360Vdc	8.881	3195	48Vdc	62.373	3005
HYD 5000-ES	520Vdc	6.160	3197	48Vdc	62.080	2988
HYD 5000-ES	580Vdc	0.4861	277	48Vdc	4.581	219
HYD 5000-ES	90Vdc	8.871	794	58Vdc	11.664	677
HYD 5000-ES	250Vdc	12.817	3189	58Vdc	51.363	2978
HYD 5000-ES	360Vdc	8.853	3193	58Vdc	51.655	2999
HYD 5000-ES	520Vdc	6.152	3196	58Vdc	52.150	3026
HYD 5000-ES	580Vdc	0.483	277	58Vdc	2.912	169
Type	U (V)	I (A) AC	P (W) AC	U (V)	I (A) DC	P (W) DC
AC charging mode						
HYD 5000-ES	207Vac	15.715	3243	46Vdc	64.926	2978
HYD 5000-ES	230Vac	14.140	3236	46Vdc	64.906	2978
HYD 5000-ES	253Vac	12.845	3229	46Vdc	64.918	2978
HYD 5000-ES	207Vac	15.959	3291	48Vdc	62.940	3030
HYD 5000-ES	230Vac	14.334	3281	48Vdc	62.921	3029
HYD 5000-ES	253Vac	13.034	3276	48Vdc	62.913	3029
HYD 5000-ES	207Vac	15.906	3268	58Vdc	51.924	3024
HYD 5000-ES	230Vac	14.246	3253	58Vdc	51.930	3024
HYD 5000-ES	253Vac	12.897	3242	58Vdc	51.944	3025
Type	U (V)	I (A) DC	P (W) DC	U (V)	I (A) AC	P (W) AC
Battery discharging mode						
HYD 5000-ES	46Vdc	69.978	3222	207Vac/50Hz	14.848	2990
HYD 5000-ES	46Vdc	69.956	3221	230Vac/50Hz	13.479	2993
HYD 5000-ES	46Vdc	69.931	3219	253Vac/50Hz	12.280	2990
HYD 5000-ES	48Vdc	66.866	3223	207Vac/50Hz	14.864	2995
HYD 5000-ES	48Vdc	66.937	3223	230Vac/50Hz	13.451	2997
HYD 5000-ES	48Vdc	67.001	3222	253Vac/50Hz	12.314	2997
HYD 5000-ES	58Vdc	56.431	3245	207Vac/50Hz	15.021	3013
HYD 5000-ES	58Vdc	56.411	3244	230Vac/50Hz	13.627	3018
HYD 5000-ES	58Vdc	56.442	3245	253Vac/50Hz	12.419	3024
HYD 5000-ES	46Vdc	69.985	3223	207Vac/60Hz	14.851	2992
HYD 5000-ES	46Vdc	69.961	3222	230Vac/60Hz	13.475	2993
HYD 5000-ES	46Vdc	69.929	3218	253Vac/60Hz	12.279	2990
HYD 5000-ES	48Vdc	66.871	3223	207Vac/60Hz	14.866	2995
HYD 5000-ES	48Vdc	66.943	3222	230Vac/60Hz	13.453	2997
HYD 5000-ES	48Vdc	67.012	3219	253Vac/60Hz	12.312	2998
HYD 5000-ES	58Vdc	56.429	3245	207Vac/60Hz	15.018	3013
HYD 5000-ES	58Vdc	56.415	3244	230Vac/60Hz	13.631	3018
HYD 5000-ES	58Vdc	56.439	3245	253Vac/60Hz	12.421	3024
Type	U (V)	I (A) DC	P (W) DC	U (V)	I (A) AC	P (W) AC
PV input for battery charging and AC output mode						
HYD 5000-ES	90Vdc	8.875	794	230Vac/50Hz	0.015	3
HYD 5000-ES				46Vdc	15.238	700
HYD 5000-ES	250Vdc	20.966	5216	230Vac/50Hz	8.569	1924
HYD 5000-ES				46Vdc	64.936	2977
HYD 5000-ES	360Vdc	14.584	5234	230Vac/50Hz	8.785	1975
HYD 5000-ES				46Vdc	64.928	2975
HYD 5000-ES	520Vdc	10.074	5237	230Vac/50Hz	9.034	2005
HYD 5000-ES				46Vdc	64.935	2972
HYD 5000-ES	580Vdc	0.488	278	230Vac/50Hz	0.012	2
HYD 5000-ES				46Vdc	4.761	218
HYD 5000-ES	90Vdc	8.713	791	230Vac/50Hz	0.013	2
HYD 5000-ES				48Vdc	14.642	704



HYD 5000-ES	250Vdc	20.755	5210	230Vac/50Hz	7.982	1785
HYD 5000-ES				48Vdc	64.929	3116
HYD 5000-ES	360Vdc	14.273	5140	230Vac/50Hz	7.948	1782
HYD 5000-ES				48Vdc	65.01	3118
HYD 5000-ES	520Vdc	10.041	5191	230Vac/50Hz	8.243	1821
HYD 5000-ES				48Vdc	64.968	3114
HYD 5000-ES	580Vdc	0.484	278	230Vac/50Hz	0.012	2
HYD 5000-ES				48Vdc	4.473	215
HYD 5000-ES	90Vdc	8.870	794	230Vac/50Hz	0.010	1
HYD 5000-ES				58Vdc	11.606	676
HYD 5000-ES	250Vdc	20.933	5215	230Vac/50Hz	8.434	1891
HYD 5000-ES				58Vdc	52.101	3032
HYD 5000-ES	360Vdc	14.631	5233	230Vac/50Hz	8.702	1951
HYD 5000-ES				58Vdc	52.02	3026
HYD 5000-ES	520Vdc	10.001	5188	230Vac/50Hz	8.517	1886
HYD 5000-ES				58Vdc	52.974	3079
HYD 5000-ES	580Vdc	0.481	277	230Vac/50Hz	0.009	1
HYD 5000-ES				58Vdc	3.669	213
HYD 5000-ES	90Vdc	8.863	792	230Vac/60Hz	0.015	3
HYD 5000-ES				46Vdc	15.234	698
HYD 5000-ES	250Vdc	20.959	5213	230Vac/60Hz	8.571	1926
HYD 5000-ES				46Vdc	64.932	2975
HYD 5000-ES	360Vdc	14.579	5229	230Vac/60Hz	8.787	1977
HYD 5000-ES				46Vdc	64.923	2973
HYD 5000-ES	520Vdc	10.063	5235	230Vac/60Hz	9.036	2007
HYD 5000-ES				46Vdc	64.932	2970
HYD 5000-ES	580Vdc	0.485	276	230Vac/60Hz	0.012	2
HYD 5000-ES				46Vdc	4.761	218
HYD 5000-ES	90Vdc	8.864	794	230Vac/60Hz	0.013	2
HYD 5000-ES				48Vdc	14.64	704
HYD 5000-ES	250Vdc	20.754	5210	230Vac/60Hz	7.976	1786
HYD 5000-ES				48Vdc	64.904	3115
HYD 5000-ES	360Vdc	14.275	5140	230Vac/60Hz	7.944	1782
HYD 5000-ES				48Vdc	64.994	3118
HYD 5000-ES	520Vdc	10.038	5190	230Vac/60Hz	8.239	1820
HYD 5000-ES				48Vdc	64.966	3114
HYD 5000-ES	580Vdc	0.484	278	230Vac/60Hz	0.011	2
HYD 5000-ES				48Vdc	4.474	215
HYD 5000-ES	90Vdc	8.922	794	230Vac/60Hz	0.010	1
HYD 5000-ES				58Vdc	11.605	676
HYD 5000-ES	250Vdc	20.933	5215	230Vac/60Hz	8.351	1872
HYD 5000-ES				58Vdc	52.407	3050
HYD 5000-ES	360Vdc	14.631	5233	230Vac/60Hz	8.696	1950
HYD 5000-ES				58Vdc	51.997	3024
HYD 5000-ES	520Vdc	10.000	5189	230Vac/60Hz	8.533	1889
HYD 5000-ES				58Vdc	52.990	3080
HYD 5000-ES	580Vdc	0.480	277	230Vac/60Hz	0.009	1
HYD 5000-ES				58Vdc	3.675	214

supplementary information



4.6, 1.62/RD	TABLE: electrical data (in normal conditions)						P
Type	U (V)	I (A) DC	P (W) DC	U (V)	I (A) AC	P (W) AC	
PV Input mode							
HYD 4600-ES	90Vdc	9.4446	851	230V/50Hz	3.4426	784	
HYD 4600-ES	230Vdc	21.0247	4779	230V/50Hz	19.6530	4539	
HYD 4600-ES	360Vdc	13.4159	4781	230V/50Hz	20.0803	4637	
HYD 4600-ES	520Vdc	9.3467	4786	230V/50Hz	19.9636	4608	
HYD 4600-ES	580Vdc	0.5193	295	230V/50Hz	1.2856	267	
HYD 4600-ES	90Vdc	9.4376	848	230V/60Hz	3.4382	780	
HYD 4600-ES	230Vdc	21.0117	4776	230V/60Hz	19.6486	4535	
HYD 4600-ES	360Vdc	13.4088	4778	230V/60Hz	20.0752	4633	
HYD 4600-ES	520Vdc	9.3329	4785	230V/60Hz	19.9351	4605	
HYD 4600-ES	580Vdc	0.5085	297	230V/60Hz	1.2912	265	
Type	U (V)	I (A) DC	P (W) DC	U (V)	I (A) DC	P (W) DC	
PV charging mode							
HYD 4600-ES	90Vdc	9.4312	845	46Vdc	16.87	776	
HYD 4600-ES	230Vdc	14.004	3221	46Vdc	64.186	2967	
HYD 4600-ES	360Vdc	9.119	3199	46Vdc	64.779	2986	
HYD 4600-ES	520Vdc	9.157	3204	46Vdc	64.885	2991	
HYD 4600-ES	580Vdc	0.521	297	46Vdc	5.891	271	
HYD 4600-ES	90Vdc	9.425	840	48Vdc	16.021	769	
HYD 4600-ES	230Vdc	14.025	3220	48Vdc	62.781	2986	
HYD 4600-ES	360Vdc	8.985	3238	48Vdc	63.597	3048	
HYD 4600-ES	520Vdc	6.187	3219	48Vdc	63.166	3035	
HYD 4600-ES	580Vdc	0.5072	290	48Vdc	5.438	261	
HYD 4600-ES	90Vdc	9.4229	839	58Vdc	13.276	770	
HYD 4600-ES	230Vdc	14.022	3225	58Vdc	51.585	2999	
HYD 4600-ES	360Vdc	9.028	3239	58Vdc	52.471	3046	
HYD 4600-ES	520Vdc	6.247	3243	58Vdc	52.882	3065	
HYD 4600-ES	580Vdc	0.506	292	58Vdc	4.552	264	
Type	U (V)	I (A) AC	P (W) AC	U (V)	I (A) DC	P (W) DC	
AC charging mode							
HYD 4600-ES	207Vac	15.762	3241	46Vdc	64.952	2992	
HYD 4600-ES	230Vac	14.257	3254	46Vdc	64.913	2987	
HYD 4600-ES	253Vac	12.92	3235	46Vdc	64.918	2988	
HYD 4600-ES	207Vac	15.801	3246	48Vdc	62.338	2996	
HYD 4600-ES	230Vac	14.256	3253	48Vdc	62.444	3001	
HYD 4600-ES	253Vac	12.934	3238	48Vdc	62.351	2996	
HYD 4600-ES	207Vac	15.766	3243	58Vdc	52.013	3020	
HYD 4600-ES	230Vac	14.067	3212	58Vdc	51.916	3015	
HYD 4600-ES	253Vac	12.961	3243	58Vdc	52.017	3021	
Type	U (V)	I (A) DC	P (W) DC	U (V)	I (A) AC	P (W) AC	
Battery discharging mode							
HYD 4600-ES	46Vdc	69.912	3217	207Vac/50Hz	14.812	2993	
HYD 4600-ES	46Vdc	69.902	3215	230Vac/50Hz	13.427	2993	
HYD 4600-ES	46Vdc	69.853	3214	253Vac/50Hz	12.25	2991	
HYD 4600-ES	48Vdc	66.792	3218	207Vac/50Hz	14.811	2998	
HYD 4600-ES	48Vdc	66.907	3217	230Vac/50Hz	13.416	3000	
HYD 4600-ES	48Vdc	66.922	3215	253Vac/50Hz	12.286	2999	
HYD 4600-ES	58Vdc	56.349	3239	207Vac/50Hz	14.989	3014	
HYD 4600-ES	58Vdc	56.373	3238	230Vac/50Hz	13.595	3021	



HYD 4600-ES	58Vdc	56.32	3238	253Vac/50Hz	12.399	3026
HYD 4600-ES	46Vdc	69.9	3216	207Vac/60Hz	14.815	2993
HYD 4600-ES	46Vdc	69.882	3215	230Vac/60Hz	13.421	2993
HYD 4600-ES	46Vdc	69.855	3214	253Vac/60Hz	12.253	2991
HYD 4600-ES	48Vdc	66.791	3219	207Vac/60Hz	14.813	2999
HYD 4600-ES	48Vdc	66.904	3217	230Vac/60Hz	13.419	3000
HYD 4600-ES	48Vdc	66.933	3215	253Vac/60Hz	12.287	2999
HYD 4600-ES	58Vdc	56.353	3240	207Vac/60Hz	14.995	3013
HYD 4600-ES	58Vdc	56.371	3239	230Vac/60Hz	13.593	3020
HYD 4600-ES	58Vdc	56.323	3238	253Vac/60Hz	12.401	3026
Type	U (V)	I (A) DC	P (W) DC	U (V)	I (A) AC	P (W) AC
PV input for battery charging and AC output mode						
HYD 4600-ES	90Vdc	9.420	848	230Vac/50Hz	0.013	2
HYD 4600-ES				46Vdc	17.283	795
HYD 4600-ES	230Vdc	21.000	4776	230Vac/50Hz	6.261	1440
HYD 4600-ES				46Vdc	64.865	2998
HYD 4600-ES	360Vdc	13.391	4798	230Vac/50Hz	6.422	1477
HYD 4600-ES				46Vdc	64.866	2995
HYD 4600-ES	520Vdc	9.322	4783	230Vac/50Hz	6.35	1460
HYD 4600-ES				46Vdc	64.973	2998
HYD 4600-ES	580Vdc	0.494	292	230Vac/50Hz	0.011	3
HYD 4600-ES				46Vdc	5.109	235
HYD 4600-ES	90Vdc	9.413	845	230Vac/50Hz	0.013	2
HYD 4600-ES				48Vdc	15.417	740
HYD 4600-ES	230Vdc	20.987	4773	230Vac/50Hz	6.161	1417
HYD 4600-ES				48Vdc	63.005	3032
HYD 4600-ES	360Vdc	13.384	4775	230Vac/50Hz	6.148	1413
HYD 4600-ES				48Vdc	63.103	3037
HYD 4600-ES	520Vdc	9.308	4782	230Vac/50Hz	6.228	1432
HYD 4600-ES				48Vdc	62.904	3025
HYD 4600-ES	580Vdc	0.484	296	230Vac/50Hz	0.013	2
HYD 4600-ES				48Vdc	5.104	245
HYD 4600-ES	90Vdc	9.419	846	230Vac/50Hz	0.013	2
HYD 4600-ES				58Vdc	13.692	794
HYD 4600-ES	230Vdc	20.987	4775	230Vac/50Hz	6.255	1443
HYD 4600-ES				58Vdc	51.621	2996
HYD 4600-ES	360Vdc	13.377	4797	230Vac/50Hz	6.425	1479
HYD 4600-ES				58Vdc	51.712	2999
HYD 4600-ES	520Vdc	9.311	4781	230Vac/50Hz	6.343	1465
HYD 4600-ES				58Vdc	51.585	2995
HYD 4600-ES	580Vdc	0.491	293	230Vac/50Hz	0.011	2
HYD 4600-ES				58Vdc	4.069	237
HYD 4600-ES	90Vdc	9.435	850	230Vac/60Hz	0.012	2
HYD 4600-ES				46Vdc	17.245	792
HYD 4600-ES	230Vdc	21.015	4778	230Vac/60Hz	6.223	1437
HYD 4600-ES				46Vdc	64.827	2995
HYD 4600-ES	360Vdc	13.406	4800	230Vac/60Hz	6.384	1474
HYD 4600-ES				46Vdc	64.828	2992
HYD 4600-ES	520Vdc	9.337	4785	230Vac/60Hz	6.312	1457
HYD 4600-ES				46Vdc	64.935	2995
HYD 4600-ES	580Vdc	0.509	294	230Vac/60Hz	0.013	3
HYD 4600-ES				46Vdc	5.071	232
HYD 4600-ES	90Vdc	9.428	847	230Vac/60Hz	0.012	2



HYD 4600-ES				48Vdc	15.379	737
HYD 4600-ES	230Vdc	21.002	4775	230Vac/60Hz	6.123	1414
HYD 4600-ES				48Vdc	62.967	3029
HYD 4600-ES	360Vdc	13.399	4777	230Vac/60Hz	6.11	1410
HYD 4600-ES				48Vdc	63.065	3034
HYD 4600-ES	520Vdc	9.323	4784	230Vac/60Hz	6.19	1429
HYD 4600-ES				48Vdc	62.866	3022
HYD 4600-ES	580Vdc	0.499	298	230Vac/60Hz	0.012	2
HYD 4600-ES				48Vdc	5.066	242
HYD 4600-ES	90Vdc	9.404	843	230Vac/60Hz	0.011	2
HYD 4600-ES				58Vdc	13.654	791
HYD 4600-ES	230Vdc	20.972	4772	230Vac/60Hz	6.217	1440
HYD 4600-ES				58Vdc	51.583	2993
HYD 4600-ES	360Vdc	13.362	4794	230Vac/60Hz	6.387	1476
HYD 4600-ES				58Vdc	51.674	2996
HYD 4600-ES	520Vdc	9.296	4778	230Vac/60Hz	6.305	1462
HYD 4600-ES				58Vdc	51.547	2992
HYD 4600-ES	580Vdc	0.476	290	230Vac/60Hz	0.013	2
HYD 4600-ES				58Vdc	4.031	234
supplementary information						

4.6, 1.62/RD		TABLE: electrical data (in normal conditions)					P
Type	U (V)	I (A) DC	P (W) DC	U (V)	I (A) AC	P (W) AC	
PV Input mode							
HYD 4000-ES	90Vdc	11.008	989	230V/50Hz	4.228	914	
HYD 4000-ES	200Vdc	20.863	4199	230V/50Hz	17.377	3989	
HYD 4000-ES	360Vdc	11.684	4139	230V/50Hz	17.450	4008	
HYD 4000-ES	520Vdc	8.156	4194	230V/50Hz	17.754	4047	
HYD 4000-ES	580Vdc	0.405	227	230V/50Hz	1.436	199	
HYD 4000-ES	90Vdc	11.120	990	230V/60Hz	4.256	912	
HYD 4000-ES	200Vdc	20.864	4187	230V/60Hz	17.322	3974	
HYD 4000-ES	360Vdc	11.632	4134	230V/60Hz	17.440	4002	
HYD 4000-ES	520Vdc	8.231	4215	230V/60Hz	17.884	4071	
HYD 4000-ES	580Vdc	0.404	227	230V/60Hz	1.435	198	
Type	U (V)	I (A) DC	P (W) DC	U (V)	I (A) DC	P (W) DC	
PV charging mode							
HYD 4000-ES	90Vdc	10.860	970	46Vdc	18.639	862	
HYD 4000-ES	200Vdc	16.186	3229	46Vdc	64.192	2964	
HYD 4000-ES	360Vdc	9.120	3201	46Vdc	64.792	2988	
HYD 4000-ES	520Vdc	9.160	3206	46Vdc	64.897	2992	
HYD 4000-ES	580Vdc	0.408	228	46Vdc	3.568	165	
HYD 4000-ES	90Vdc	10.859	971	48Vdc	17.943	862	
HYD 4000-ES	200Vdc	15.998	3222	48Vdc	62.792	2988	
HYD 4000-ES	360Vdc	8.991	3243	48Vdc	63.601	3051	
HYD 4000-ES	520Vdc	6.193	3223	48Vdc	63.177	3041	
HYD 4000-ES	580Vdc	0.398	228	48Vdc	3.554	171	
HYD 4000-ES	90Vdc	10.645	959	58Vdc	14.468	841	
HYD 4000-ES	200Vdc	16.188	3229	58Vdc	51.583	2997	
HYD 4000-ES	360Vdc	9.030	3244	58Vdc	52.483	3048	
HYD 4000-ES	520Vdc	6.251	3245	58Vdc	52.885	3069	



HYD 4000-ES	580Vdc	0.396	226	58Vdc	2.875	167
Type	U (V)	I (A) AC	P (W) AC	U (V)	I (A) DC	P (W) DC
AC charging mode						
HYD 4000-ES	207Vac	15.795	3246	46Vdc	64.985	2994
HYD 4000-ES	230Vac	14.290	3259	46Vdc	64.946	2989
HYD 4000-ES	253Vac	12.953	3240	46Vdc	64.951	2990
HYD 4000-ES	207Vac	15.834	3251	48Vdc	62.371	2998
HYD 4000-ES	230Vac	14.289	3258	48Vdc	62.477	3003
HYD 4000-ES	253Vac	12.967	3243	48Vdc	62.384	2998
HYD 4000-ES	207Vac	15.799	3248	58Vdc	52.046	3022
HYD 4000-ES	230Vac	14.100	3217	58Vdc	51.949	3017
HYD 4000-ES	253Vac	12.994	3248	58Vdc	52.050	3023
Type	U (V)	I (A) DC	P (W) DC	U (V)	I (A) AC	P (W) AC
Battery discharging mode						
HYD 4000-ES	46Vdc	69.980	3223	207Vac/50Hz	14.840	2991
HYD 4000-ES	46Vdc	69.970	3221	230Vac/50Hz	13.455	2991
HYD 4000-ES	46Vdc	69.921	3220	253Vac/50Hz	12.278	2989
HYD 4000-ES	48Vdc	66.860	3224	207Vac/50Hz	14.839	2996
HYD 4000-ES	48Vdc	66.975	3223	230Vac/50Hz	13.444	2998
HYD 4000-ES	48Vdc	66.990	3221	253Vac/50Hz	12.314	2997
HYD 4000-ES	58Vdc	56.417	3245	207Vac/50Hz	15.017	3012
HYD 4000-ES	58Vdc	56.441	3244	230Vac/50Hz	13.623	3019
HYD 4000-ES	58Vdc	56.388	3244	253Vac/50Hz	12.427	3024
HYD 4000-ES	46Vdc	69.968	3222	207Vac/60Hz	14.843	2991
HYD 4000-ES	46Vdc	69.950	3221	230Vac/60Hz	13.449	2991
HYD 4000-ES	46Vdc	69.923	3220	253Vac/60Hz	12.281	2989
HYD 4000-ES	48Vdc	66.859	3225	207Vac/60Hz	14.841	2997
HYD 4000-ES	48Vdc	66.972	3223	230Vac/60Hz	13.447	2998
HYD 4000-ES	48Vdc	67.001	3221	253Vac/60Hz	12.315	2997
HYD 4000-ES	58Vdc	56.421	3246	207Vac/60Hz	15.023	3011
HYD 4000-ES	58Vdc	56.439	3245	230Vac/60Hz	13.621	3018
HYD 4000-ES	58Vdc	56.391	3244	253Vac/60Hz	12.429	3024
Type	U (V)	I (A) DC	P (W) DC	U (V)	I (A) AC	P (W) AC
PV input for battery charging and AC output mode						
HYD 4000-ES	90Vdc	10.742	961	230Vac/50Hz	0.013	2
HYD 4000-ES				46Vdc	18.530	857
HYD 4000-ES	200Vdc	21.110	4213	230Vac/50Hz	4.256	920
HYD 4000-ES				46Vdc	64.867	2995
HYD 4000-ES	360Vdc	11.698	4200	230Vac/50Hz	4.400	955
HYD 4000-ES				46Vdc	64.868	2993
HYD 4000-ES	520Vdc	8.115	4203	230Vac/50Hz	4.578	971
HYD 4000-ES				46Vdc	64.979	2996
HYD 4000-ES	580Vdc	0.399	227	230Vac/50Hz	0.013	2
HYD 4000-ES				46Vdc	3.754	173
HYD 4000-ES	90Vdc	10.733	961	230Vac/50Hz	0.013	2
HYD 4000-ES				48Vdc	17.809	859
HYD 4000-ES	200Vdc	21.242	4215	230Vac/50Hz	4.118	887
HYD 4000-ES				48Vdc	63.003	3037
HYD 4000-ES	360Vdc	11.618	4187	230Vac/50Hz	4.328	939
HYD 4000-ES				48Vdc	63.104	3039
HYD 4000-ES	520Vdc	8.187	4242	230Vac/50Hz	4.644	994
HYD 4000-ES				48Vdc	62.906	3027
HYD 4000-ES	580Vdc	0.407	227	230Vac/50Hz	0.012	2



HYD 4000-ES				48Vdc	3.559	171
HYD 4000-ES	90Vdc	10.592	958	230Vac/50Hz	0.010	1
HYD 4000-ES				58Vdc	14.576	848
HYD 4000-ES	200Vdc	20.897	4205	230Vac/50Hz	4.294	922
HYD 4000-ES				58Vdc	51.887	3015
HYD 4000-ES	360Vdc	11.777	4239	230Vac/50Hz	4.597	996
HYD 4000-ES				58Vdc	51.974	3018
HYD 4000-ES	520Vdc	8.178	4243	230Vac/50Hz	4.765	1022
HYD 4000-ES				58Vdc	52.183	3029
HYD 4000-ES	580Vdc	0.397	226	230Vac/50Hz	0.010	1
HYD 4000-ES				58Vdc	2.966	172
HYD 4000-ES	90Vdc	10.601	958	230Vac/60Hz	0.010	1
HYD 4000-ES				46Vdc	18.54	857
HYD 4000-ES	200Vdc	21.112	4212	230Vac/60Hz	4.252	921
HYD 4000-ES				46Vdc	64.865	2993
HYD 4000-ES	360Vdc	11.698	4200	230Vac/60Hz	4.412	956
HYD 4000-ES				46Vdc	64.870	2994
HYD 4000-ES	520Vdc	8.114	4204	230Vac/60Hz	4.574	976
HYD 4000-ES				46Vdc	64.981	2995
HYD 4000-ES	580Vdc	0.397	226	230Vac/60Hz	0.012	2
HYD 4000-ES				46Vdc	3.752	173
HYD 4000-ES	90Vdc	10.774	961	230Vac/60Hz	0.012	1
HYD 4000-ES				48Vdc	17.806	859
HYD 4000-ES	200Vdc	21.158	4212	230Vac/60Hz	4.099	883
HYD 4000-ES				48Vdc	62.967	3035
HYD 4000-ES	360Vdc	11.621	4188	230Vac/60Hz	4.332	941
HYD 4000-ES				48Vdc	63.11	3040
HYD 4000-ES	520Vdc	8.191	4243	230Vac/60Hz	4.646	995
HYD 4000-ES				48Vdc	62.911	3027
HYD 4000-ES	580Vdc	0.395	226	230Vac/60Hz	0.013	2
HYD 4000-ES				48Vdc	3.559	171
HYD 4000-ES	90Vdc	10.581	952	230Vac/60Hz	0.010	1
HYD 4000-ES				58Vdc	14.569	847
HYD 4000-ES	200Vdc	20.895	4203	230Vac/60Hz	4.289	920
HYD 4000-ES				58Vdc	51.877	3014
HYD 4000-ES	360Vdc	11.769	4237	230Vac/60Hz	4.594	995
HYD 4000-ES				58Vdc	51.968	3016
HYD 4000-ES	520Vdc	8.168	4241	230Vac/60Hz	4.759	1021
HYD 4000-ES				58Vdc	52.178	3027
HYD 4000-ES	580Vdc	0.398	226	230Vac/60Hz	0.010	1
HYD 4000-ES				58Vdc	2.965	172

supplementary information

4.6, 1.62/RD		TABLE: electrical data (in normal conditions)					P
Type	U (V)	I (A) DC	P (W) DC	U (V)	I (A) AC	P (W) AC	
PV Input mode							
HYD 3600-ES	90Vdc	11.76	1049	230V/50Hz	4.458	968	
HYD 3600-ES	180Vdc	20.956	3762	230V/50Hz	15.566	3566	
HYD 3600-ES	360Vdc	10.531	3808	230V/50Hz	15.976	3659	
HYD 3600-ES	520Vdc	7.545	3864	230V/50Hz	16.390	3735	
HYD 3600-ES	580Vdc	0.351	197	230V/50Hz	2.373	138	



HYD 3600-ES	90Vdc	11.761	1053	230V/60Hz	4.463	973
HYD 3600-ES	180Vdc	21.005	3801	230V/60Hz	15.741	3602
HYD 3600-ES	360Vdc	10.637	3820	230V/60Hz	16.013	3670
HYD 3600-ES	520Vdc	7.549	3869	230V/60Hz	16.458	3746
HYD 3600-ES	580Vdc	0.348	196	230V/60Hz	2.369	138
Type	U (V)	I (A) DC	P (W) DC	U (V)	I (A) DC	P (W) DC
PV charging mode						
HYD 3600-ES	90Vdc	11.627	1048	46Vdc	20.276	935
HYD 3600-ES	180Vdc	18.155	3262	46Vdc	64.946	2993
HYD 3600-ES	360Vdc	8.864	3194	46Vdc	64.947	2990
HYD 3600-ES	520Vdc	6.137	3195	46Vdc	64.96	2988
HYD 3600-ES	580Vdc	0.348	197	46Vdc	3.127	144
HYD 3600-ES	90Vdc	11.725	1049	48Vdc	19.618	943
HYD 3600-ES	180Vdc	18.052	3267	48Vdc	62.367	3006
HYD 3600-ES	360Vdc	8.999	3252	48Vdc	63.447	3056
HYD 3600-ES	520Vdc	6.269	3257	48Vdc	63.369	3050
HYD 3600-ES	580Vdc	0.347	198	48Vdc	2.937	141
HYD 3600-ES	90Vdc	11.657	1048	58Vdc	15.966	929
HYD 3600-ES	180Vdc	18.057	3264	58Vdc	52.053	3025
HYD 3600-ES	360Vdc	9.024	3244	58Vdc	52.447	3046
HYD 3600-ES	520Vdc	6.242	3246	58Vdc	52.968	3073
HYD 3600-ES	580Vdc	0.343	196	58Vdc	2.369	138
Type	U (V)	I (A) AC	P (W) AC	U (V)	I (A) DC	P (W) DC
AC charging mode						
HYD 3600-ES	207Vac	15.887	3266	46Vdc	64.93	2996
HYD 3600-ES	230Vac	14.359	3275	46Vdc	64.822	2991
HYD 3600-ES	253Vac	13.033	3261	46Vdc	64.925	2995
HYD 3600-ES	207Vac	15.865	3262	48Vdc	62.459	3002
HYD 3600-ES	230Vac	14.341	3272	48Vdc	62.559	3006
HYD 3600-ES	253Vac	13.015	3258	48Vdc	62.655	3011
HYD 3600-ES	207Vac	15.919	3272	58Vdc	51.858	3011
HYD 3600-ES	230Vac	14.319	3263	58Vdc	51.85	3010
HYD 3600-ES	253Vac	13.081	3273	58Vdc	51.745	3005
Type	U (V)	I (A) DC	P (W) DC	U (V)	I (A) AC	P (W) AC
Battery discharging mode						
HYD 3600-ES	46Vdc	69.957	3221	207Vac/50Hz	14.844	2991
HYD 3600-ES	46Vdc	69.938	3219	230Vac/50Hz	13.467	2990
HYD 3600-ES	46Vdc	69.926	3219	253Vac/50Hz	12.286	2989
HYD 3600-ES	48Vdc	66.833	3223	207Vac/50Hz	14.837	2994
HYD 3600-ES	48Vdc	66.922	3222	230Vac/50Hz	13.437	2997
HYD 3600-ES	48Vdc	66.965	3222	253Vac/50Hz	12.301	2996
HYD 3600-ES	58Vdc	56.427	3246	207Vac/50Hz	15.021	3012
HYD 3600-ES	58Vdc	56.428	3245	230Vac/50Hz	13.634	3019
HYD 3600-ES	58Vdc	56.422	3244	253Vac/50Hz	12.420	3024
HYD 3600-ES	46Vdc	69.961	3223	207Vac/60Hz	14.841	2992
HYD 3600-ES	46Vdc	69.943	3220	230Vac/60Hz	13.447	2990
HYD 3600-ES	46Vdc	69.929	3219	253Vac/60Hz	12.288	2989
HYD 3600-ES	48Vdc	66.829	3224	207Vac/60Hz	14.839	2994
HYD 3600-ES	48Vdc	66.928	3223	230Vac/60Hz	13.439	2997
HYD 3600-ES	48Vdc	66.967	3222	253Vac/60Hz	12.306	2996
HYD 3600-ES	58Vdc	56.435	3245	207Vac/60Hz	15.026	3013
HYD 3600-ES	58Vdc	56.431	3243	230Vac/60Hz	13.629	3017
HYD 3600-ES	58Vdc	56.417	3244	253Vac/60Hz	12.426	3024



Type	U (V)	I (A) DC	P (W) DC	U (V)	I (A) AC	P (W) AC
PV input for battery charging and AC output mode						
HYD 3600-ES	90Vdc	11.773	1049	230Vac/50Hz	0	0
HYD 3600-ES				46Vdc	20.281	936
HYD 3600-ES	180Vdc	21.164	3808	230Vac/50Hz	2.679	529
HYD 3600-ES				46Vdc	64.958	2993
HYD 3600-ES	360Vdc	10.558	3819	230Vac/50Hz	2.902	588
HYD 3600-ES				46Vdc	64.955	2990
HYD 3600-ES	520Vdc	7.392	3844	230Vac/50Hz	3.152	632
HYD 3600-ES				46Vdc	64.968	2989
HYD 3600-ES	580Vdc	0.346	196	230Vac/50Hz	0	0
HYD 3600-ES				46Vdc	3.128	144
HYD 3600-ES	90Vdc	11.65	1048	230Vac/50Hz	0.015	3
HYD 3600-ES				48Vdc	19.615	942
HYD 3600-ES	180Vdc	21.014	3804	230Vac/50Hz	2.380	453
HYD 3600-ES				48Vdc	63.859	3065
HYD 3600-ES	360Vdc	10.723	3842	230Vac/50Hz	2.861	579
HYD 3600-ES				48Vdc	63.478	3057
HYD 3600-ES	520Vdc	7.402	3845	230Vac/50Hz	2.934	577
HYD 3600-ES				48Vdc	63.353	3049
HYD 3600-ES	580Vdc	0.347	199	230Vac/50Hz	0	0
HYD 3600-ES				48Vdc	2.939	142
HYD 3600-ES	90Vdc	11.787	1049	230Vac/50Hz	0	0
HYD 3600-ES				58Vdc	15.959	928
HYD 3600-ES	180Vdc	21.172	3810	230Vac/50Hz	2.765	549
HYD 3600-ES				58Vdc	51.593	2998
HYD 3600-ES	360Vdc	10.685	3841	230Vac/50Hz	2.924	588
HYD 3600-ES				58Vdc	52.373	3041
HYD 3600-ES	520Vdc	7.420	3846	230Vac/50Hz	3.082	617
HYD 3600-ES				58Vdc	52.477	3046
HYD 3600-ES	580Vdc	0.342	196	230Vac/50Hz	0	0
HYD 3600-ES				58Vdc	2.369	138
HYD 3600-ES	90Vdc	11.695	1049	230Vac/60Hz	0.150	3
HYD 3600-ES				46Vdc	20.281	936
HYD 3600-ES	180Vdc	20.984	3803	230Vac/60Hz	2.644	522
HYD 3600-ES				46Vdc	64.950	2993
HYD 3600-ES	360Vdc	10.638	3821	230Vac/60Hz	3.020	620
HYD 3600-ES				46Vdc	64.944	2990
HYD 3600-ES	520Vdc	7.393	3844	230Vac/60Hz	3.150	632
HYD 3600-ES				46Vdc	64.953	2988
HYD 3600-ES	580Vdc	0.342	196	230Vac/60Hz	0	0
HYD 3600-ES				46Vdc	3.128	144
HYD 3600-ES	90Vdc	11.645	1048	230Vac/60Hz	0.160	4
HYD 3600-ES				48Vdc	19.614	943
HYD 3600-ES	180Vdc	21.014	3804	230Vac/60Hz	2.391	454
HYD 3600-ES				48Vdc	63.869	3066
HYD 3600-ES	360Vdc	10.626	3839	230Vac/60Hz	2.847	576
HYD 3600-ES				48Vdc	63.461	3056
HYD 3600-ES	520Vdc	7.403	3845	230Vac/60Hz	2.927	576
HYD 3600-ES				48Vdc	63.348	3048
HYD 3600-ES	580Vdc	0.345	198	230Vac/60Hz	0	0
HYD 3600-ES				48Vdc	2.939	142
HYD 3600-ES	90Vdc	11.658	1048	230Vac/60Hz	0.012	2



HYD 3600-ES				58Vdc	15.954	928
HYD 3600-ES	180Vdc	21.17	3810	230Vac/60Hz	2.697	531
HYD 3600-ES				58Vdc	51.865	3014
HYD 3600-ES	360Vdc	10.685	3841	230Vac/60Hz	2.926	588
HYD 3600-ES				58Vdc	52.360	3041
HYD 3600-ES	520Vdc	7.422	3845	230Vac/60Hz	3.079	616
HYD 3600-ES				58Vdc	52.481	3047
HYD 3600-ES	580Vdc	0.352	196	230Vac/60Hz	0	0
HYD 3600-ES				58Vdc	2.369	138
supplementary information						

4.6, 1.62/RD	TABLE: electrical data (in normal conditions)						P
Type	U (V)	I (A) DC	P (W) DC	U (V)	I (A) AC	P (W) AC	
PV Input mode							
HYD 3000-ES	90Vdc	13.136	1185	230V/50Hz	4.984	1094	
HYD 3000-ES	160Vdc	19.706	3164	230V/50Hz	13.099	2990	
HYD 3000-ES	360Vdc	8.701	3134	230V/50Hz	13.182	3011	
HYD 3000-ES	520Vdc	6.074	3102	230V/50Hz	13.217	2999	
HYD 3000-ES	580Vdc	0.317	177	230V/50Hz	1.274	149	
HYD 3000-ES	90Vdc	13.215	1184	230V/60Hz	5.0121	1093	
HYD 3000-ES	160Vdc	19.349	3110	230V/60Hz	12.893	2940	
HYD 3000-ES	360Vdc	8.742	3108	230V/60Hz	13.182	3012	
HYD 3000-ES	520Vdc	6.100	3114	230V/60Hz	13.283	3010	
HYD 3000-ES	580Vdc	0.327	177	230V/60Hz	1.276	149	
Type	U (V)	I (A) DC	P (W) DC	U (V)	I (A) DC	P (W) DC	
PV charging mode							
HYD 3000-ES	90Vdc	13.286	1186	46Vdc	23.001	1059	
HYD 3000-ES	160Vdc	19.638	3159	46Vdc	62.903	2892	
HYD 3000-ES	360Vdc	8.652	3124	46Vdc	63.301	2908	
HYD 3000-ES	520Vdc	6.089	3156	46Vdc	64.303	2951	
HYD 3000-ES	580Vdc	0.308	177	46Vdc	2.562	118	
HYD 3000-ES	90Vdc	13.131	1184	48Vdc	22.018	1060	
HYD 3000-ES	160Vdc	19.813	3166	48Vdc	60.312	2901	
HYD 3000-ES	360Vdc	8.670	3125	48Vdc	60.603	2913	
HYD 3000-ES	520Vdc	6.033	3127	48Vdc	61.010	2930	
HYD 3000-ES	580Vdc	0.313	176	48Vdc	2.549	123	
HYD 3000-ES	90Vdc	13.068	1182	58Vdc	18.144	1056	
HYD 3000-ES	160Vdc	19.769	3165	58Vdc	50.304	2923	
HYD 3000-ES	360Vdc	8.844	3194	58Vdc	51.682	3002	
HYD 3000-ES	520Vdc	6.089	3157	58Vdc	51.488	2988	
HYD 3000-ES	580Vdc	0.316	178	58Vdc	2.059	120	
Type	U (V)	I (A) AC	P (W) AC	U (V)	I (A) DC	P (W) DC	
AC charging mode							
HYD 3000-ES	207Vac	15.887	3265	46Vdc	64.89	2995	
HYD 3000-ES	230Vac	14.359	3276	46Vdc	64.818	2991	
HYD 3000-ES	253Vac	13.033	3262	46Vdc	64.919	2993	
HYD 3000-ES	207Vac	15.858	3263	48Vdc	62.454	3000	
HYD 3000-ES	230Vac	14.339	3273	48Vdc	62.561	3004	
HYD 3000-ES	253Vac	13.017	3257	48Vdc	62.648	3010	
HYD 3000-ES	207Vac	15.921	3269	58Vdc	51.543	2993	
HYD 3000-ES	230Vac	14.316	3258	58Vdc	51.64	2999	



HYD 3000-ES	253Vac	13.079	3271	58Vdc	51.539	2993
Type	U (V)	I (A) DC	P (W) DC	U (V)	I (A) AC	P (W) AC
Battery discharging mode						
HYD 3000-ES	46Vdc	69.983	3222	207Vac/50Hz	14.840	2991
HYD 3000-ES	46Vdc	69.942	3220	230Vac/50Hz	13.451	2990
HYD 3000-ES	46Vdc	69.913	3220	253Vac/50Hz	12.285	2990
HYD 3000-ES	48Vdc	66.811	3222	207Vac/50Hz	14.840	2995
HYD 3000-ES	48Vdc	67.011	3223	230Vac/50Hz	13.444	2998
HYD 3000-ES	48Vdc	67.001	3222	253Vac/50Hz	12.316	2997
HYD 3000-ES	58Vdc	56.432	3245	207Vac/50Hz	15.025	3012
HYD 3000-ES	58Vdc	56.422	3244	230Vac/50Hz	13.65	3019
HYD 3000-ES	58Vdc	56.395	3243	253Vac/50Hz	12.425	3023
HYD 3000-ES	46Vdc	69.985	3221	207Vac/60Hz	14.839	2990
HYD 3000-ES	46Vdc	69.938	3221	230Vac/60Hz	13.450	2989
HYD 3000-ES	46Vdc	69.889	3218	253Vac/60Hz	12.264	2988
HYD 3000-ES	48Vdc	66.809	3221	207Vac/60Hz	14.839	2994
HYD 3000-ES	48Vdc	67.017	3223	230Vac/60Hz	13.439	2998
HYD 3000-ES	48Vdc	67.008	3222	253Vac/60Hz	12.314	2997
HYD 3000-ES	58Vdc	56.435	3245	207Vac/60Hz	15.029	3012
HYD 3000-ES	58Vdc	56.427	3244	230Vac/60Hz	13.650	3019
HYD 3000-ES	58Vdc	56.401	3243	253Vac/60Hz	12.427	3024
Type	U (V)	I (A) DC	P (W) DC	U (V)	I (A) AC	P (W) AC
PV input for battery charging and AC output mode						
HYD 3000-ES	90Vdc	13.289	1185	230Vac/50Hz	0.012	1
HYD 3000-ES				46Vdc	23.011	1060
HYD 3000-ES	160Vdc	19.641	3160	230Vac/50Hz	0.013	2
HYD 3000-ES				46Vdc	62.913	2893
HYD 3000-ES	360Vdc	8.649	3123	230Vac/50Hz	0.012	2
HYD 3000-ES				46Vdc	63.307	2909
HYD 3000-ES	520Vdc	6.089	3157	230Vac/50Hz	0.01	1
HYD 3000-ES				46Vdc	64.282	2950
HYD 3000-ES	580Vdc	0.315	177	230Vac/50Hz	0	0
HYD 3000-ES				46Vdc	2.667	123
HYD 3000-ES	90Vdc	13.238	1186	230Vac/50Hz	0	0
HYD 3000-ES				48Vdc	22.014	1060
HYD 3000-ES	160Vdc	19.374	3144	230Vac/50Hz	0	0
HYD 3000-ES				48Vdc	60.303	2900
HYD 3000-ES	360Vdc	8.670	3125	230Vac/50Hz	0	0
HYD 3000-ES				48Vdc	60.598	2912
HYD 3000-ES	520Vdc	6.001	3125	230Vac/50Hz	0	0
HYD 3000-ES				48Vdc	60.996	2930
HYD 3000-ES	580Vdc	0.312	178	230Vac/50Hz	0.015	3
HYD 3000-ES				48Vdc	2.533	123
HYD 3000-ES	90Vdc	13.255	1186	230Vac/50Hz	0	0
HYD 3000-ES				58Vdc	18.145	1056
HYD 3000-ES	160Vdc	19.768	3165	230Vac/50Hz	0	0
HYD 3000-ES				58Vdc	50.289	2922
HYD 3000-ES	360Vdc	8.843	3193	230Vac/50Hz	0	0
HYD 3000-ES				58Vdc	51.667	3000
HYD 3000-ES	520Vdc	6.088	3157	230Vac/50Hz	0	0
HYD 3000-ES				58Vdc	51.47	2987
HYD 3000-ES	580Vdc	0.32	178	230Vac/50Hz	0	0
HYD 3000-ES				58Vdc	2.061	120



HYD 3000-ES	90Vdc	13.291	1186	230Vac/60Hz	0.012	1
HYD 3000-ES				46Vdc	23.013	1061
HYD 3000-ES	160Vdc	19.642	3161	230Vac/60Hz	0.013	2
HYD 3000-ES				46Vdc	62.915	2891
HYD 3000-ES	360Vdc	8.651	3124	230Vac/60Hz	0.012	2
HYD 3000-ES				46Vdc	63.311	2911
HYD 3000-ES	520Vdc	6.111	3155	230Vac/60Hz	0.01	1
HYD 3000-ES				46Vdc	64.287	2951
HYD 3000-ES	580Vdc	0.317	178	230Vac/60Hz	0	0
HYD 3000-ES				46Vdc	2.669	122
HYD 3000-ES	90Vdc	13.148	1184	230Vac/60Hz	0	0
HYD 3000-ES				48Vdc	22.011	1060
HYD 3000-ES	160Vdc	19.816	3166	230Vac/60Hz	0.015	3
HYD 3000-ES				48Vdc	60.300	2901
HYD 3000-ES	360Vdc	8.669	3125	230Vac/60Hz	0	0
HYD 3000-ES				48Vdc	60.592	2912
HYD 3000-ES	520Vdc	6.035	3129	230Vac/60Hz	0.17	5
HYD 3000-ES				48Vdc	60.990	2929
HYD 3000-ES	580Vdc	0.314	178	230Vac/60Hz	0.015	3
HYD 3000-ES				48Vdc	2.532	123
HYD 3000-ES	90Vdc	13.167	1185	230Vac/60Hz	0	0
HYD 3000-ES				58Vdc	18.156	1056
HYD 3000-ES	160Vdc	19.768	3164	230Vac/60Hz	0	0
HYD 3000-ES				58Vdc	50.279	2923
HYD 3000-ES	360Vdc	8.922	3195	230Vac/60Hz	0	0
HYD 3000-ES				58Vdc	51.662	3000
HYD 3000-ES	520Vdc	6.088	3157	230Vac/60Hz	0	0
HYD 3000-ES				58Vdc	51.462	2987
HYD 3000-ES	580Vdc	0.312	179	230Vac/60Hz	0	0
HYD 3000-ES				58Vdc	2.062	120

supplementary information

5.1.1 and 2.1.1.7/RD	TABLE: discharge of capacitors in the primary circuit				P
Condition	τ calculated (s)	τ measured (s)	t u→ 0V (s)	Comments	
AC output	--	--	--		
AC input	--	--	0.18s		
Note(s):					

5.3.1 and 2.6.3.4/RD	TABLE: Resistance of earthing measurement			P
Location	Resistance measured (m Ω)	Comments		
PE and enclosure	10.8	55A		
Supplementary information:				

5.5 and 8.3	TABLE: Abnormal operating and fault conditions			P
-------------	--	--	--	----------



		Ambient temperature (°C)				24.6			—
		Power source for EUT: Manufacturer, model/type, output rating				Chroma		—	
component No.	fault	test condition		test time	fuse No.	fault condition		result	
		AC	DC			AC	DC		
Relay RY1 defect	Short circuit before energized	230V 0.02A	520V 0.02A	3Min.	--	230V 0.02A	520V 0.02A	Indicate Relay fault, error code "ID55" (RecoverRelayFail). Do not connect to AC mainsn. No damage, no hazards.	
Relay RY2 defect	Short circuit before energized	230V 0.02A	520V 0.02A	3Min.	--	230V 0.02A	520V 0.02A	Indicate Relay fault, error code "ID55" (RecoverRelayFail). Do not connect to AC mainsn. No damage, no hazards.	
Relay RY3 defect	Short circuit before energized	230V 0.02A	520V 0.02A	3Min.	--	230V 0.02A	520V 0.02A	Indicate Relay fault, error code "ID55" (RecoverRelayFail). Do not connect to AC mainsn. No damage, no hazards.	
Relay RY4 defect	Short circuit before energized	230V 0.02A	520V 0.02A	3Min.	--	230V 0.02A	520V 0.02A	Indicate Relay fault, error code "ID55" (RecoverRelayFail). Do not connect to AC mainsn. No damage, no hazards.	
Relay RY5 defect	Short circuit before energized	230V 0.02A	520V 0.02A	3Min.	--	230V 0.02A	520V 0.02A	Indicate Relay fault, error code "ID55" (RecoverRelayFail). Do not connect to AC mainsn. No damage, no hazards.	
Relay RY6 defect	Short circuit before energized	230V 0.02A	520V 0.02A	3Min.	--	230V 0.02A	520V 0.02A	Indicate Relay fault, error code "ID55" (RecoverRelayFail). Do not connect to AC mainsn. No damage, no hazards.	
Monitoring voltage defect R508	short	230V 26.2A	520V 12.1A	3Min.	--	230V 0.02A	520V 0.02A	Output a.c. relays operated, disconnected with grid. Q59 damage. No hazards.	
Monitoring voltage defect Q59 pin 1-2	short	230V 26.2A	520V 12.1A	3Min.	--	230V 0.02A	520V 0.02A	Output a.c. relays operated, disconnected with grid , error code "ID55" (RecoverRelayFail). No damage, no hazards.	
Monitoring voltage defect U46 pin 1-2	short	230V 26.2A	520V 12.1A	3Min.	--	230V 0.02A	520V 0.02A	Output a.c. relays operated, disconnected with grid , error code "ID55" (RecoverRelayFail). U46 damage, no hazards.	
Monitoring voltage defect R511	short	230V 26.2A	520V 12.1A	3Min.	--	230V 0.02A	520V 0.02A	Output a.c. relays operated, disconnected with grid , error code "ID55" (RecoverRelayFail). U46 damage, no hazards.	



Monitoring voltage defect R509	open	230V 26.2A	520V 12.1A	3Min.	--	230V 0.02A	520V 0.02A	The unit was in check state. No damage. No hazards.
Monitoring voltage defect U46 pin 3-4	short	230V 26.2A	520V 12.1A	3Min.	--	230V 0.02A	520V 0.02A	Output a.c. relays operated, disconnected with grid , error code "ID55" (RecoverRelayFail). U46 damage, no hazards.
Voltage measurement disabled R204	Open	230V 26.2A	520V 12.1A	3Min.	--	230V 0.02A	520V 0.02A	Output a.c. relays operated, disconnected with grid , error code "ID01" (The grid voltage is too high). No damage. No hazards.
L to N (grid)	Short circuit	230V 26.2A	520V 12.1A	3Min.	--	0V 0A	520V 0.02A	Output a.c. relays operated, disconnected with grid. No damage. No hazards.
PV+ to PV-	Short circuit	230V 0.02A	520V 0.02A	3Min.	--	230V 0.02A	520V 0.02A	Output a.c. relays operated, disconnected with grid. No damage. No hazards.
L to N (off-grid)	Short circuit	230V 14.0A	58V 56.4A	3Min.	--	0V 0A	58V 0.1A	No damage. No hazards.
L to N (off-grid)	Over load	230V 14.0A	58V 56.4A	3Min.	--	0V 0A	58V 0.1A	The EUT shut down immediately, indicate over current, error code "over load". No damage, no hazards.
PV+ to PV-	Reversed	230V 0.02A	520V 0.02A	3Min.	--	230V 0.02A	520V 0.02A	Do not connect to AC mains, can reset by remove fault condition. No damage, no hazards.
BAT+ to BAT-	Reversed	230V 0.02A	520V 0.02A	3Min.	--	230V 0.02A	520V 0.02A	Battery did not join to the system. No damage, no hazards.
L to N(grid)	Reversed	230V 0.02A	500V 0.02A	3Min.	--	230V 0.02A	500V 0.02A	EUT operationed normally. No damage, no hazards.
Loss of control XL1	Short	230V 26.2A	520V 12.1A	3Min.	--	230V 0.02A	520V 0.02A	Output a.c. relays operated, disconnected with grid , error code "ID53, ID54" (SPI communication is fault, SCI communication is fault). No damage. No hazards.
Loss of control C738(3.3VDD)	Short	230V 26.2A	520V 12.1A	3Min.	--	230V 0.02A	520V 0.02A	Output a.c. relays operated, disconnected with grid , error code "ID53, ID54" (SPI communication is fault, SCI communication is fault). No damage. No hazards.



Communication microcontroller defect U4 pin1 to pin2	Short	230V 26.2A	520V 12.1A	3Min.	--	230V 0.02A	520V 0.02A	Output a.c. relays operated, disconnected with grid , error code "ID53, ID54, ID75" (SPI communication is fault, SCI communication is fault, Unrecoverable EEPROM write). No damage. No hazards.
ISO defect R531	Short circuit before energized	230V 26.2A	520V 12.1A	3Min.	--	230V 0.02A	520V 0.02A	Indicate ISO fault, error code "ID56" (The insulation resistance is too low). Do not connect to AC mainsn. No damage, no hazards.
ISO defect R598	Open circuit before energized	230V 0.02A	520V 0.02A	3Min.	--	230V 0.02A	520V 0.02A	Indicate ISO fault, error code "ID56" (The insulation resistance is too low). Do not connect to AC mainsn. No damage, no hazards.
ISO defect R602	Short circuit before energized	230V 0.02A	520V 0.02A	3Min.	--	230V 0.02A	520V 0.02A	Indicate ISO fault, error code "ID56" (The insulation resistance is too low). Do not connect to AC mainsn. No damage, no hazards.
ISO defect R605	Open circuit before energized	230V 0.02A	520V 0.02A	3Min.	--	230V 0.02A	520V 0.02A	Indicate ISO fault, error code "ID56" (The insulation resistance is too low). Do not connect to AC mainsn. No damage, no hazards.
ISO defect R355	Short circuit before energized	230V 0.02A	520V 0.02A	3Min.	--	230V 0.02A	520V 0.02A	Indicate ISO fault, error code "ID56" (The insulation resistance is too low). Do not connect to AC mainsn. No damage, no hazards.
ISO defect R303	Open circuit before energized	230V 0.02A	520V 0.02A	3Min.	--	230V 0.02A	520V 0.02A	Indicate ISO fault, error code "ID56" (The insulation resistance is too low). Do not connect to AC mainsn. No damage, no hazards.
ISO defect R307	Short circuit before energized	230V 0.02A	520V 0.02A	3Min.	--	230V 0.02A	520V 0.02A	Indicate ISO fault, error code "ID56" (The insulation resistance is too low). Do not connect to AC mainsn. No damage, no hazards.
ISO defect U23 pin 13-14	Short circuit before energized	230V 0.02A	520V 0.02A	3Min.	--	230V 0.02A	520V 0.02A	Indicate ISO fault, error code "ID56" (The insulation resistance is too low). Do not connect to AC mainsn. No damage, no hazards.
GFCI defect R292	Open	230V 26.2A	520V 12.1A	3Min.	--	230V 0.02A	520V 0.02A	Indicate GFCI fault, error code "ID48" (The GFCI sampling value between the master DSP and slave DSP is not consistent). Do not connect to AC mainsn. No damage, no hazards.



GFCI defect R297	Open	230V 26.2A	520V 12.1A	3Min.	--	230V 0.02A	520V 0.02A	Indicate GFCI fault, error code "ID48" (The GFCI sampling value between the master DSP and slave DSP is not consistent). Do not connect to AC mains. No damage, no hazards.
T2 pin 1-3	Short	230V 26.2A	520V 12.1A	3Min.	--	230V 0.02A	520V 0.02A	The EUT shut down immediately. The displayer was not work. No damage, no hazards.
T2 pin 5-6	Short	230V 26.2A	520V 12.1A	3Min.	--	230V 0.02A	520V 0.02A	The EUT shut down immediately. The displayer was not work. No damage, no hazards.
T2 pin 8-7	Short	230V 26.2A	520V 12.1A	3Min.	--	230V 0.02A	520V 0.02A	The EUT shut down immediately. The displayer was not work. D84 damaged, no hazards.
T2 pin 12-10	Short	230V 26.2A	520V 12.1A	3Min.	--	230V 0.02A	520V 0.02A	The EUT shut down immediately. The displayer was not work. D86, D134 D damaged, no hazards.
Q12 pin D-S	Short	230V 26.2A	520V 12.1A	3Min.	--	230V 0.02A	520V 0.02A	The EUT shut down immediately, output a.c. relays operated, disconnected with grid. Q12 damaged. No hazards.
Q23 pin D-S	Short	230V 26.2A	520V 12.1A	3Min.	--	230V 0.02A	520V 0.02A	The EUT shut down immediately, output a.c. relays operated, disconnected with grid. Q23 damaged. No hazards.
Q16 pin D-S	Short	230V 26.2A	520V 12.1A	3Min.	--	230V 0.02A	520V 0.02A	The EUT shut down immediately, output a.c. relays operated, disconnected with grid. Q16 damaged. No hazards.
Q21 pin D-S	Short	230V 26.2A	520V 12.1A	3Min.	--	230V 0.02A	520V 0.02A	The EUT shut down immediately, output a.c. relays operated, disconnected with grid. Q21 damaged. No hazards.
Q7 pin D-S	Short	230V 26.2A	520V 12.1A	3Min.	--	230V 0.02A	520V 0.02A	The EUT shut down immediately, output a.c. relays operated, disconnected with grid. Q7 damaged. No hazards.
Q9 pin D-S	Short	230V 26.2A	520V 12.1A	3Min.	--	230V 0.02A	520V 0.02A	The EUT shut down immediately, output a.c. relays operated, disconnected with grid. Q9, Q13 damaged. No hazards.



Q13 pin D-S	Short	230V 26.2A	520V 12.1A	3Min.	--	230V 0.02A	520V 0.02A	The EUT shut down immediately, output a.c. relays operated, disconnected with grid. Q9,Q13 damaged. No hazards.
Q4 pin D-S	Short	230V 26.2A	520V 12.1A	3Min.	--	230V 0.02A	520V 0.02A	The EUT shut down immediately, output a.c. relays operated, disconnected with grid. Q1,Q2,Q3,Q6 damaged. No hazards.
Q6 pin D-S	Short	230V 26.2A	520V 12.1A	3Min.	--	230V 0.02A	520V 0.02A	The EUT shut down immediately, output a.c. relays operated, disconnected with grid. Q1,Q2,Q3,Q6 damaged. No hazards.
See technical documentation.								

5.7 and 2.10.2/RD	Table: Working voltage measurement				N/A
Location	RMS voltage (V)	Peak voltage (V)	Comments		
Supplementary information:					

5.7 and 2.10.4/RD	TABLE: Clearance and creepage distance measurements						P
clearance cl and creepage distance dcr at / of:	Up (V)	U r.m.s. (V)	required cl (mm)	cl (mm)	required dcr (mm)	dcr (mm)	
Primary circuits to secondary circuits on PCB board (RI)	--	230	5.5	6.20	5.5	6.20	
Optocoupler pin 1 to pin 3 on PCB board (RI) (U15,U14, U20, U16, U17, U18, U19, U30)	--	230	5.5	7.70	5.5	7.70	
Primary circuits to secondary circuits on PCB board (RI)	600	--	6.4	7.60	6.4	7.60	
Primary circuits to earthing on PCB board (BI)	600	--	3.2	5.50	3.2	5.50	
Y capacitor (C132, C137, C141, C141) to earthing on PCB board (BI)	600	--	3.2	5.50	3.2	5.50	
Relay (RY3- RY6) two polarity on PCB board (BI)	600	--	3.2	3.30	3.2	3.30	
Y capacitor (C104,C114, C105, C113) to earthing on PCB board (BI)	--	230	3.0	5.50	3.0	5.50	
Y capacitor (C105,C113,C97,C92) to earthing on PCB board (BI)	--	230	3.0	5.50	3.0	5.50	



5.7 and 2.10.4/RD	TABLE: Clearance and creepage distance measurements						P
Y capacitor (C30, C31) to earthing on PCB board (BI) (Main board)	600	--	3.2	5.50	4.5	5.50	
Primary circuits to earthing on PCB board (BI) (Main board)	600	--	3.2	5.50	3.2	5.50	
Supplementary information: RI: Reinforced insulation, DI: double insulation, BI: basic insulation, SI: supplementary insulation The double side PCB layout is considered and evaluated.							



5.8, 2.1.1.3/RD and 2.10.5.1 /RD	TABLE: Distance through insulation measurements					P
Distance through insulation (DTI) at/of:	U peak (V)	U r.m.s. (V)	Test voltage (V)	Required DTI (mm)	DTI (mm)	
Insulation sheet	600	4594	--	0.13	0.13	
Photo coupler (certified)*	600	4594	0.2	0.4	0.4	
Supplementary information:						

6, 8.2 and 9	TABLE: Electric strength tests, impulse tests and voltage surge tests				P
test voltage applied between:	test voltage (V)	impulse withstand voltage (V)	partial discharge extinction voltage (V)	result	
AC Output terminal to communication port	4240	6000	—	Pass	
DC input terminal to communication port	4594	6000	—	Pass	
Battery terminal to earthed enclosure	2545	4000	—	Pass	
Battery terminal to communication port	4594	6000	—	Pass	
Insulation sheet	2545	4000	—	Pass	
One layer of insulation tape	4594	6000	—	Pass	
Relay pin 3 to pin 4	2545	4000	—	Pass	
Supplementary information:					

7.4, 4.5.5/RD	TABLE: Ball pressure test of thermoplastic parts			P
	Allowed impression diameter (mm)	≤ 2 mm		—
Part	Test temperature (°C)	Impression diameter (mm)		
Transformer bobbin	125	1.6		
Supplementary information:				

4.3	TABLE: heating temperature rise measurements (PV input for all AC output mode)				P
	Test voltage (V)	A: 300Vdc/20.7A; 230Vac,25.8A B: 300Vdc/10.7A; 230Vac,13.0A C: 520Vdc/12.1A; 230Vac,26.2A D: 520Vdc/6.15A; 230Vac,13.0A			—
	t1 (°C)	See below			—
	t2 (°C)	See below			—
Temperature T of part/at:	Measured T (°C)				Limit T (°C)
	A	B	C	D	
Ambient	45.86	60.61	45.34	60.54	--



Battery input connector	55.28	62.77	53.00	61.48	120
PV input line	56.99	62.68	53.34	61.29	105
Battery input line	55.17	63.31	53.59	62.07	105
DC swtich body	58.39	63.61	55.87	62.45	70
T2 winding	63.97	67.99	62.67	66.50	110
R534	66.13	69.19	65.32	67.79	155
D134	66.06	69.20	65.21	67.79	130
Q18	86.10	76.50	78.22	72.95	130
Q17	76.81	73.77	76.82	72.07	130
Q22	76.77	73.88	77.16	72.27	130
EC2	66.44	69.43	65.36	67.97	105
D13	91.62	80.04	88.63	76.51	130
Q26	105.56	86.89	102.88	84.09	130
Optocoupler_U2	88.83	79.46	85.54	77.10	100
R30	85.02	76.45	84.19	76.74	155
Q25	108.09	87.72	104.83	85.28	130
Q12	87.43	77.35	87.07	75.88	130
Q7	86.10	76.83	86.44	75.37	130
Q6	104.90	84.41	106.65	81.94	130
Q5	105.10	84.29	107.03	81.27	130
C13	75.30	72.95	74.74	71.25	105
L8 winding	78.60	73.97	75.25	72.31	105
L8 core	75.68	73.95	75.34	72.10	105
Q8	74.10	73.72	74.85	72.01	130
Q14	76.12	73.55	77.49	71.93	130
C8	73.06	73.61	72.87	71.98	130
Relay RY3 enclosure	75.20	74.17	74.96	72.72	85
T3 body	78.04	75.66	79.75	76.17	130
Power PCB	62.37	66.65	61.00	65.23	130
T1 winding	77.05	78.74	77.74	78.68	110
T1 core	78.15	79.84	79.13	80.05	110
Master DSP	72.42	76.18	71.59	74.59	105
AC connector	58.14	63.54	56.24	62.13	105
AC_L line	62.61	64.98	60.69	63.56	105
Power PCB	64.24	67.10	63.59	65.94	130
PV connector	45.98	60.70	45.88	61.32	90
CF375	64.04	67.00	62.92	65.69	105
DC swtich knob	47.65	61.81	46.47	61.11	70
C4	85.10	77.09	82.96	74.48	105
PF18 line	71.07	70.43	69.83	68.77	120
INV L Line	90.75	76.45	92.93	75.59	105
C107	75.54	71.76	73.98	70.01	100
L9 winding	82.01	73.54	80.72	72.01	105
L10 winding	78.60	74.06	76.75	72.39	105
C94	77.17	73.76	75.93	71.93	110
RL3	75.29	72.66	74.27	70.89	85
R297	72.21	71.72	70.77	70.01	155
L8 winding	75.73	69.98	74.81	68.09	105
L15 winding	67.04	66.96	60.78	64.72	105
C142	66.09	67.45	62.32	65.67	105
UC32	69.90	69.73	66.44	68.20	125
Output PCB	97.11	79.76	96.61	77.06	130
INV inductor L line	103.10	81.57	102.99	81.34	105



INV inductor N line	104.06	82.94	103.98	82.18	105
BOOST inductor 1	99.74	83.17	93.08	77.95	105
BOOST inductor 1	98.10	82.43	89.87	77.00	105
Displayer	62.17	65.32	59.72	63.78	75
Mounting bracket	66.04	67.68	66.35	65.77	90

supplementary information:

*The symol 14 of Annex C is marked on the heating sink.

4.3	TABLE: heating temperature rise measurements (PV input for battery charging and AC output mode)				P
	Test voltage (V)	E: 300Vdc/20.6A; 230Vac,12.6A F: 300Vdc/11.0A; 230Vac,13.4A G: 520Vdc/12.0A; 230Vac,13.0A H: 520Vdc/6.2A; 230Vac,13.4A			—
	t1 (°C)	See below			—
	t2 (°C)	See below			—
Temperature T of part/at:	Measured T (°C)				Limit T (°C)
	E	F	G	H	
Ambient	45.73	60.42	45.59	60.29	--
Battery input connector	51.22	64.93	54.17	61.11	120
PV input line	59.89	64.14	55.05	61.54	105
Battery input line	50.30	65.22	53.68	61.14	105
DC swtich body	61.78	65.24	57.62	62.81	70
T2 winding	71.61	75.83	58.82	73.80	110
R534	68.98	76.94	58.49	72.83	155
D134	66.00	73.75	57.72	71.73	130
Q18	69.14	78.26	56.73	73.19	130
Q17	73.88	80.39	58.50	74.67	130
Q22	73.94	79.68	59.22	75.14	130
EC2	65.85	75.03	58.27	73.11	105
D13	88.84	83.98	62.91	75.77	130
Q26	102.35	91.11	60.97	75.31	130
Optocoupler_U2	86.09	83.72	62.56	76.24	100
R30	82.62	91.75	64.23	84.59	155
Q25	111.17	92.14	62.43	75.93	130
Q12	84.50	83.31	63.02	77.62	130
Q7	83.48	89.80	64.61	80.48	130
Q6	108.40	83.87	78.37	82.92	130
Q5	108.10	82.27	78.54	82.47	130
C13	79.40	74.63	63.30	74.20	105
L8 winding	73.54	77.39	63.95	76.73	105
L8 core	73.81	77.12	64.43	77.04	105
Q8	71.30	79.60	59.79	76.93	130
Q14	73.25	79.36	60.82	77.02	130
C8	76.60	76.98	61.12	76.05	130
Relay RY3 enclosure	82.60	76.44	62.64	75.85	85
T3 body	81.48	76.84	67.95	80.16	130
Power PCB	60.04	71.85	53.20	68.75	130
T1 winding	80.81	80.45	69.04	81.87	110
T1 core	81.95	81.60	70.61	83.54	110
Master DSP	75.93	78.36	70.66	76.70	105
AC connector	62.05	63.69	57.13	63.00	105
AC_L line	66.58	65.13	59.88	64.16	105



Power PCB	61.83	72.98	54.16	68.20	130
PV connector	46.26	60.72	47.30	60.51	90
CF375	61.54	69.99	62.14	68.88	105
DC swtich knob	46.67	62.09	48.00	60.57	70
C4	88.86	77.30	75.25	75.85	105
PF18 line	68.56	76.02	57.62	72.82	120
INV L Line	93.73	74.91	77.52	76.69	105
C107	79.15	71.89	68.84	71.94	100
L9 winding	85.35	73.36	72.44	73.91	105
L10 winding	81.26	73.72	70.66	74.00	105
C94	79.93	73.27	70.49	74.00	110
RL3	79.19	73.47	68.32	72.01	85
R297	75.36	71.79	67.27	71.40	155
L8 winding	79.14	69.08	66.82	69.95	105
L15 winding	77.28	68.30	60.08	65.69	105
C142	69.78	68.51	62.16	66.93	105
UC32	73.43	71.56	63.87	70.19	125
Output PCB	99.37	77.44	80.13	78.82	130
INV inductor L line	103.23	78.74	85.88	81.95	105
INV inductor N line	102.79	80.48	86.80	84.23	105
BOOST inductor 1	104.15	83.98	78.64	82.90	105
BOOST inductor 1	102.51	84.73	77.26	81.27	105
Displayer	65.28	66.03	59.32	65.46	75
Mounting bracket	68.74	69.23	56.36	69.58	90

supplementary information:

*The symol 14 of Annex C is marked on the heating sink.

4.3	TABLE: heating temperature rise measurements (AC charging mode)				P	
	Test voltage (V)	I: 207Vac/15.7A;48V/63A J: 207Vac/9.5A;48V/45A K: 253Vac/13.1A;48V/63A L: 253Vac/8.0A;48V/45A			—	
	t1 (°C)	See below			—	
	t2 (°C)	See below			—	
Temperature T of part/at:		Measured T (°C)			Limit T (°C)	
		I	J	K	L	
	Ambient	45.02	60.85	45.04	59.54	--
	Battery input connector	54.55	61.86	52.59	61.71	120
	PV input line	52.23	62.39	52.62	61.89	105
	Battery input line	59.11	62.77	52.00	62.49	105
	DC swtich body	55.68	63.47	55.88	63.25	70
	T2 winding	70.48	77.52	67.06	73.84	110
	R534	77.65	80.31	65.95	73.67	155
	D134	72.17	73.81	65.03	72.03	130
	Q18	79.50	73.92	62.48	73.65	130
	Q17	81.60	74.39	63.34	74.39	130
	Q22	81.39	74.24	63.64	74.14	130
	EC2	70.82	74.76	66.37	73.01	105
	D13	72.99	72.13	63.25	72.03	130
	Q26	74.14	72.58	64.00	72.62	130
	Optocoupler_U2	77.74	73.61	67.19	73.92	100
	R30	89.52	82.05	70.67	83.20	155



Q25	73.59	72.24	63.96	72.11	130
Q12	77.30	74.53	64.82	74.59	130
Q7	95.60	82.23	66.31	82.26	130
Q6	81.14	75.50	65.94	75.10	130
Q5	78.92	74.92	64.80	74.42	130
C13	71.05	71.75	69.21	72.08	105
L8 winding	78.27	74.36	71.75	74.65	105
L8 core	77.58	73.91	72.85	74.57	105
Q8	75.77	76.35	66.17	76.19	130
Q14	76.52	75.84	65.45	75.62	130
C8	72.66	74.91	67.77	75.07	130
Relay RY3 enclosure	71.96	74.42	67.41	74.63	85
T3 body	72.56	76.35	70.16	77.06	130
Power PCB	73.63	69.38	61.10	69.58	130
T1 winding	73.76	79.28	73.47	80.11	110
T1 core	75.11	80.32	74.96	81.39	110
Master DSP	70.09	76.96	67.91	77.22	105
AC connector	52.78	64.02	51.75	63.32	105
AC_L line	55.18	64.82	53.42	64.19	105
Power PCB	90.01	69.03	60.87	69.76	130
PV connector	45.43	61.23	45.92	60.51	90
CF375	83.15	68.09	64.27	68.23	105
DC swtich knob	45.64	61.06	45.66	61.57	70
C4	72.52	71.10	70.24	71.51	105
PF18 line	105.34	71.81	64.57	72.04	120
INV L Line	72.86	71.23	65.98	71.13	105
C107	67.00	69.22	65.67	69.70	100
L9 winding	69.37	70.62	66.65	71.18	105
L10 winding	68.80	72.10	66.75	72.63	105
C94	68.19	72.30	66.46	72.98	110
RL3	67.69	71.13	64.06	71.58	85
R297	65.51	70.66	64.31	70.99	155
L8 winding	63.22	67.87	59.94	68.05	105
L15 winding	58.31	65.91	58.54	66.02	105
C142	60.46	66.89	60.92	67.11	105
UC32	64.76	69.09	62.72	69.27	125
Output PCB	74.70	75.19	68.98	75.53	130
INV inductor L line	78.35	73.64	70.02	73.47	105
INV inductor N line	79.44	73.89	71.79	74.02	105
BOOST inductor 1	77.11	73.30	73.58	73.93	105
BOOST inductor 2	77.15	73.54	73.70	74.07	105
Displayer	58.77	65.64	58.45	65.84	75
Mounting bracket	62.44	69.26	57.68	68.71	90

supplementary information:

*The symol 14 of Annex C is marked on the heating sink.

4.3	TABLE: heating temperature rise measurements (Battery discharging mode)		P
	Test voltage (V)	M: 46Vdc/70A;230Vac/13.5A N: 46Vdc/45.0A;230Vac/9.5A O: 58Vdc/56A;230Vac/14.0A P: 58Vdc/37A; 230Vac/9.0A	—
	t1 (°C)	See below	—



**BUREAU
VERITAS**

Test Report No.: LD190808N030-1

t2 (°C)	See below				—
Temperature T of part/at:	Measured T (°C)				Limit T (°C)
	M	N	O	P	
Ambient	45.51	59.92	45.07	60.03	--
Battery input connector	47.55	63.78	59.30	62.00	120
PV input line	47.29	62.15	54.93	62.24	105
Battery input line	47.34	65.43	64.97	63.21	105
DC swtich body	48.54	63.60	57.89	63.19	70
T2 winding	62.28	77.09	74.19	74.52	110
R534	63.11	79.94	84.66	76.30	155
D134	61.83	78.40	76.60	73.63	130
Q18	50.83	77.99	84.92	76.78	130
Q17	50.71	78.89	86.96	77.93	130
Q22	50.98	79.63	87.07	78.62	130
EC2	59.27	74.50	74.39	73.49	105
D13	50.43	73.51	74.56	72.88	130
Q26	50.77	74.14	75.95	73.59	130
Optocoupler_U2	52.35	76.81	83.01	76.49	100
R30	52.29	86.64	89.36	84.08	155
Q25	50.58	74.94	75.88	74.26	130
Q12	50.80	87.15	96.72	85.43	130
Q7	51.25	81.06	87.55	79.84	130
Q6	51.65	77.15	81.30	77.02	130
Q5	51.10	76.17	80.09	75.88	130
C13	55.57	71.17	73.03	71.87	105
L8 winding	55.96	75.61	81.92	75.91	105
L8 core	56.49	75.29	81.33	75.80	105
Q8	52.67	74.58	74.03	73.53	130
Q14	51.27	74.01	73.99	73.14	130
C8	54.84	73.33	73.68	73.28	130
Relay RY3 enclosure	54.52	72.82	72.34	73.06	85
T3 body	53.46	73.14	71.65	74.92	130
Power PCB	51.65	73.30	81.74	72.65	130
T1 winding	59.43	77.27	74.58	78.86	110
T1 core	60.25	78.44	76.15	80.14	110
Master DSP	59.50	75.62	71.51	76.34	105
AC connector	47.46	62.63	54.36	63.28	105
AC_L line	48.20	63.71	56.92	64.05	105
Power PCB	50.71	76.36	89.99	75.06	130
PV connector	46.27	60.97	45.90	60.97	90
CF375	50.47	73.61	82.89	72.51	105
DC swtich knob	45.78	61.95	45.96	61.05	70
C4	56.79	70.79	73.98	72.30	105
PF18 line	51.30	83.20	106.95	81.33	120
INV L Line	51.79	70.32	72.62	70.99	105
C107	53.80	68.55	68.82	68.98	100
L9 winding	54.59	69.85	70.86	70.43	105
L10 winding	54.46	70.48	69.91	71.72	105
C94	53.19	70.93	69.68	72.26	110
RL3	51.23	71.46	70.08	71.60	85
R297	54.05	69.75	66.94	70.35	155
L8 winding	50.91	66.51	64.60	67.44	105
L15 winding	50.52	65.00	59.93	65.29	105

**Bureau Veritas Shenzhen Co., Ltd.
Dongguan Branch**

No. 34, Chenwulu Section, Guantai Rd.,
Houjie Town, Dongguan City, Guangdong
523942, China

Tel: +86 769 8998 2098
Fax: +86 769 8599 1080
Email: customerservice.dg@cn.bureauveritas.com
REPORT IEC 62040-1 VER.0



C142	51.94	65.78	62.02	66.30	105
UC32	52.45	68.58	66.66	68.56	125
Output PCB	53.46	73.58	75.23	74.49	130
INV inductor L line	52.59	73.97	76.10	74.01	105
INV inductor N line	53.39	75.28	78.27	75.17	105
BOOST inductor 1	54.41	75.82	78.01	75.25	105
BOOST inductor 2	54.20	76.24	78.35	75.68	105
Displayer	49.73	64.21	60.42	65.19	75
Mounting bracket	48.54	66.86	61.46	67.63	90

supplementary information:

*The symol 14 of Annex C is marked on the heating sink.

C.2/RD	Safety isolation transformer		N/A
Construction details:			
Transformer part name:			
Manufacturer:			
Type:			
Recurring peak voltage	--	--	
Required clearance for reinforced insulation (from table 2H and 2J)	--	--	
	--	--	
Effective voltage rms	--	--	
Required creepage distance for reinforced insulation (from table 2L)	--	--	
Measured min. creepage distance			
Location	inside (mm)	outside (mm)	
--	--	--	
--	--	--	
Measured min. clearances			
Location	inside (mm)	outside (mm)	
--	--	--	
--	--	--	
Construction:			
Pin numbers			



Prim.	--
Sec.	--
Bobbin	
Material	--
Thickness	--
Electric strength test	--
With AC 3000V after humidity treatment	--
Result	--

M	Ventilation of battery compartments	N/A
	<p>The required dimension for the ventilation openings will be calculated with the following formula:</p> $A > K1 * Q$ <p>with $Q = (0.054 \text{ m}^3/\text{Ah}) * n * I * C$</p> <p>where:</p> <p>K1 : constant factor of $28 \text{ h} * \text{cm}^2/\text{m}^3$</p> <p>Q : airflow in m^3/h</p> <p>n : number of battery cells</p> <p>I : constant factor (0,2A/100Ah for valve regulated lead acid batteries)</p> <p>C: nominal capacity of the battery</p>	
	<p>With the specific data for the UPS the following dimension for the ventilation openings is required:</p> <p>n : ?</p> <p>C : ?</p> $A > 28 \text{ h} * \text{cm}^2/\text{m}^3 * (0.054 \text{ m}^3/\text{Ah}) * n * 0.2 \text{ A}/100 \text{ Ah} * C$ $A > ? \text{ cm}^2$	
	Verdict	
	The size of ventilation openings in battery cabinet exceeds the required airflow by far (as well as the UPS).	



Enclosure front view



Enclosure rear view





Enclosure front and side view



Enclosure rear and side view

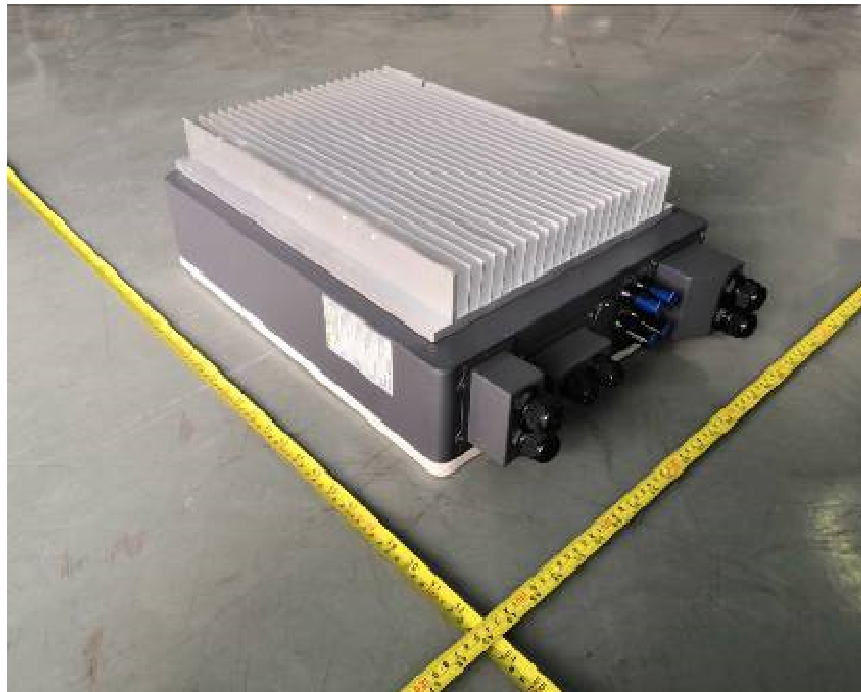



Enclosure Bottom view



Internal view: HYD 6000-ES, HYD 5000-ES, HYD 4600-ES





Internal view: HYD 4000-ES, HYD 3600-ES, HYD 3000-ES

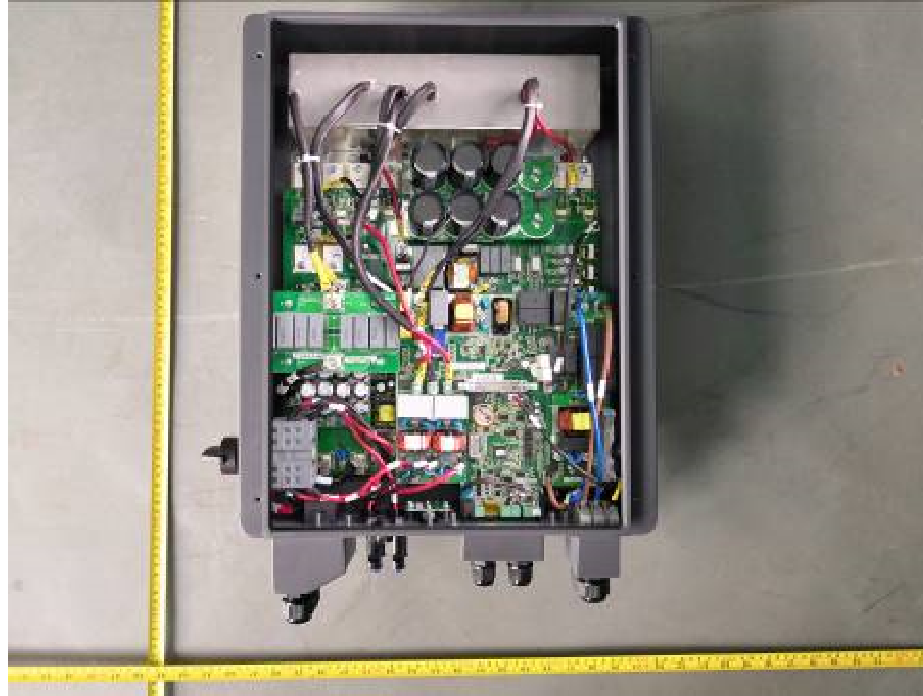

Internal view-1

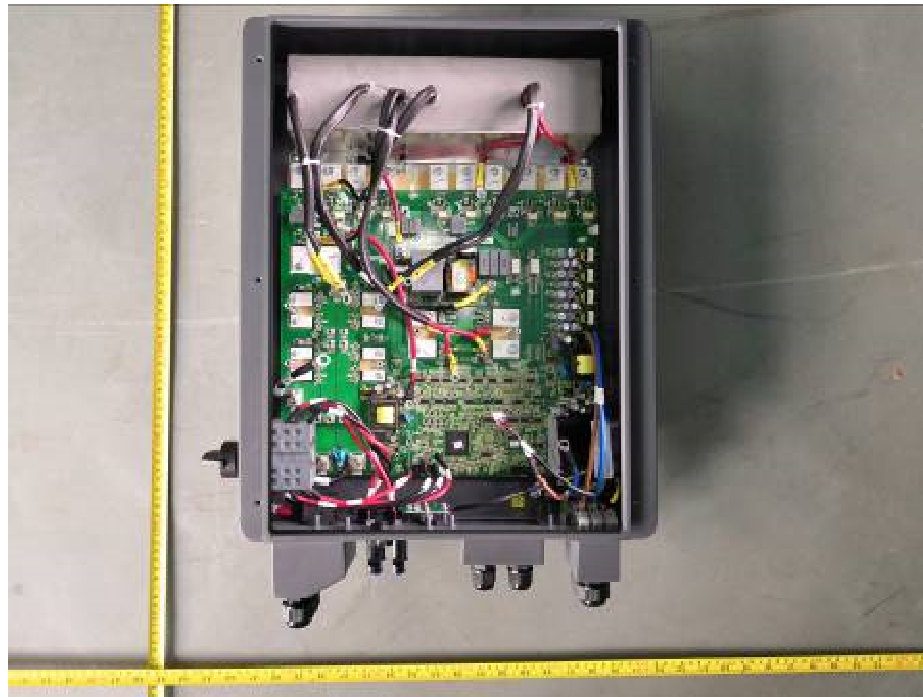



Internal view-2

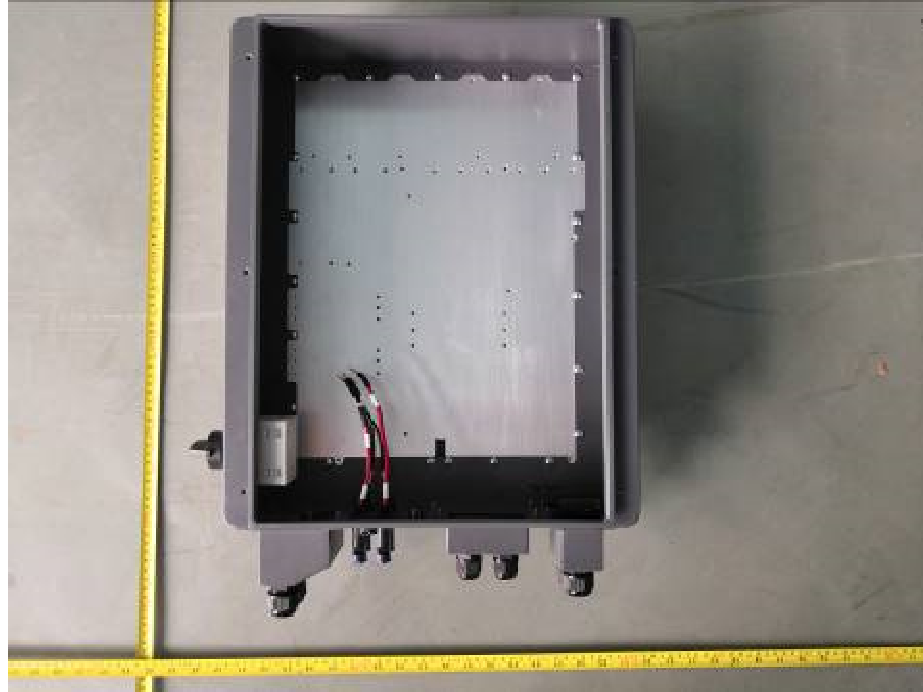

Internal view: Ground terminal





Main power board component side view



Main power board solder side view

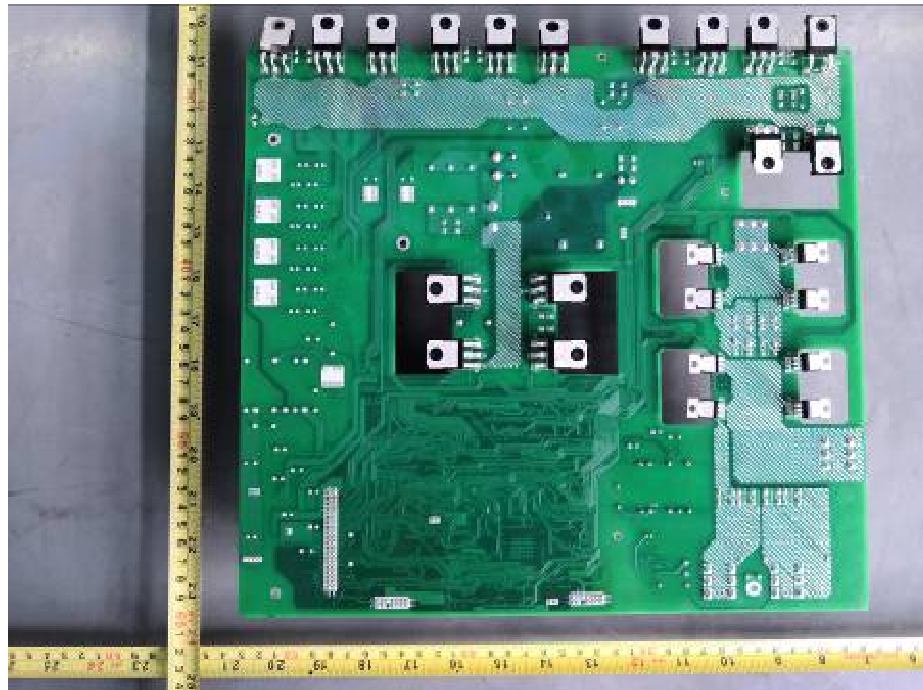



Input&output board component side view



Input&output board solder side view

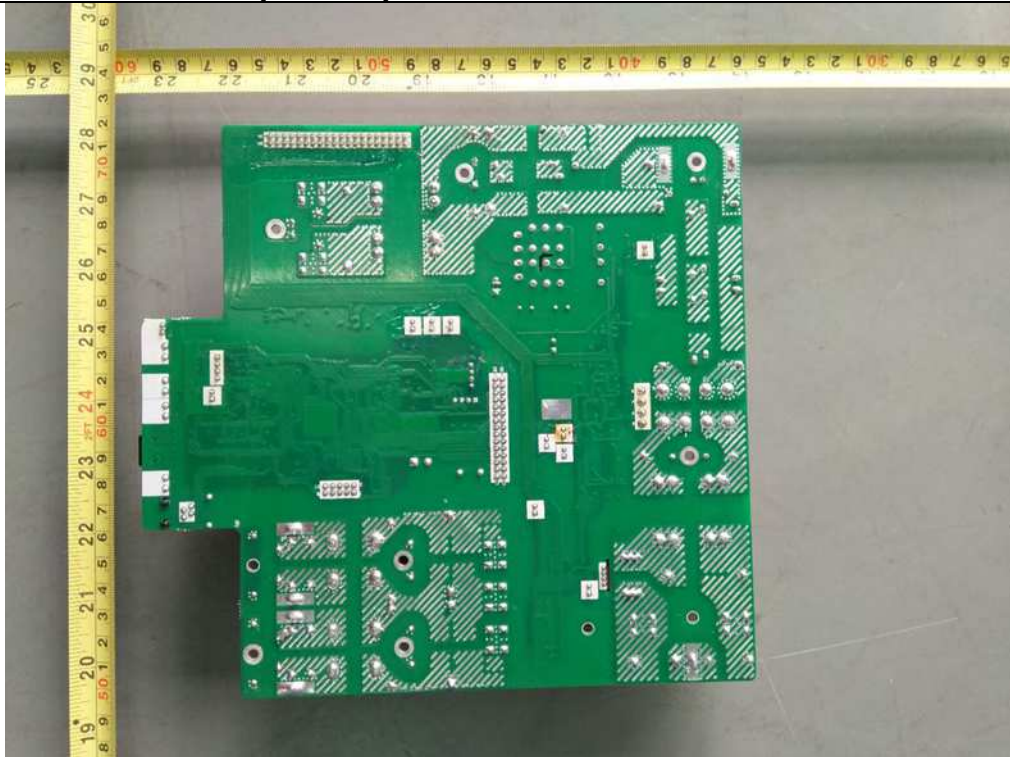



Capcitance board component side view: HYD 6000-ES, HYD 5000-ES, HYD 4600-ES

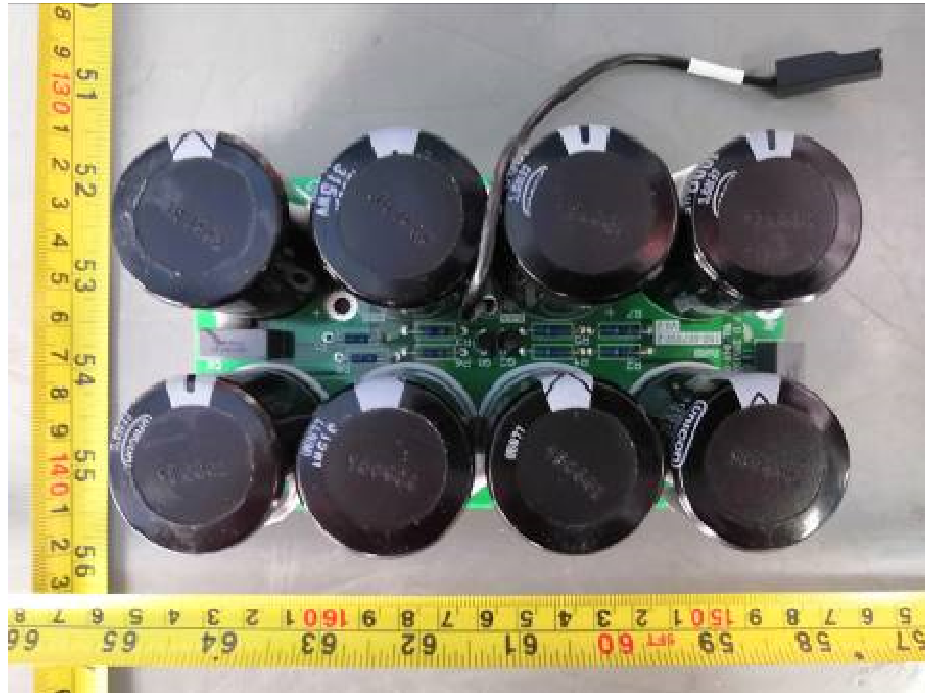

Capcitance board solder side view: HYD 6000-ES, HYD 5000-ES, HYD 4600-ES

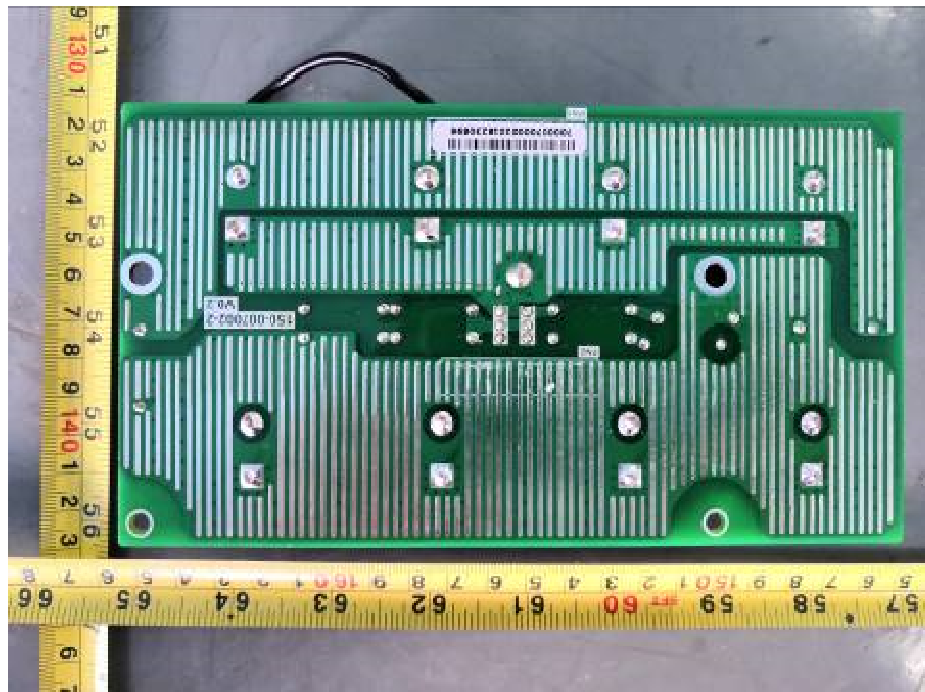



Capcitance board component side view: HYD 4000-ES, HYD 3600-ES, HYD 3000-ES



Capcitance board solder side view: HYD 4000-ES, HYD 3600-ES, HYD 3000-ES

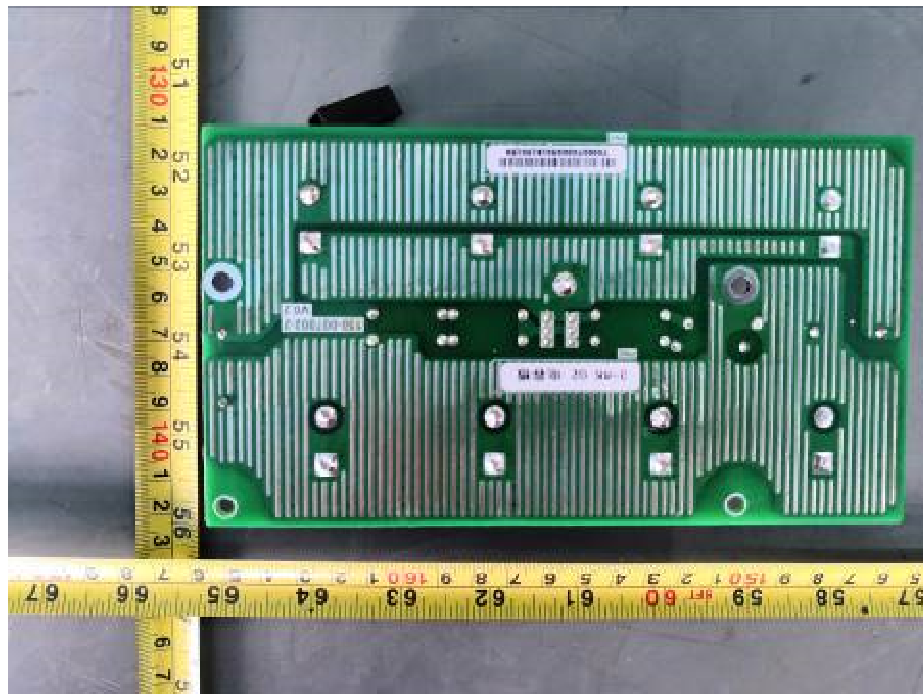



Capcittance B board component side view



Capcittance B board solder side view

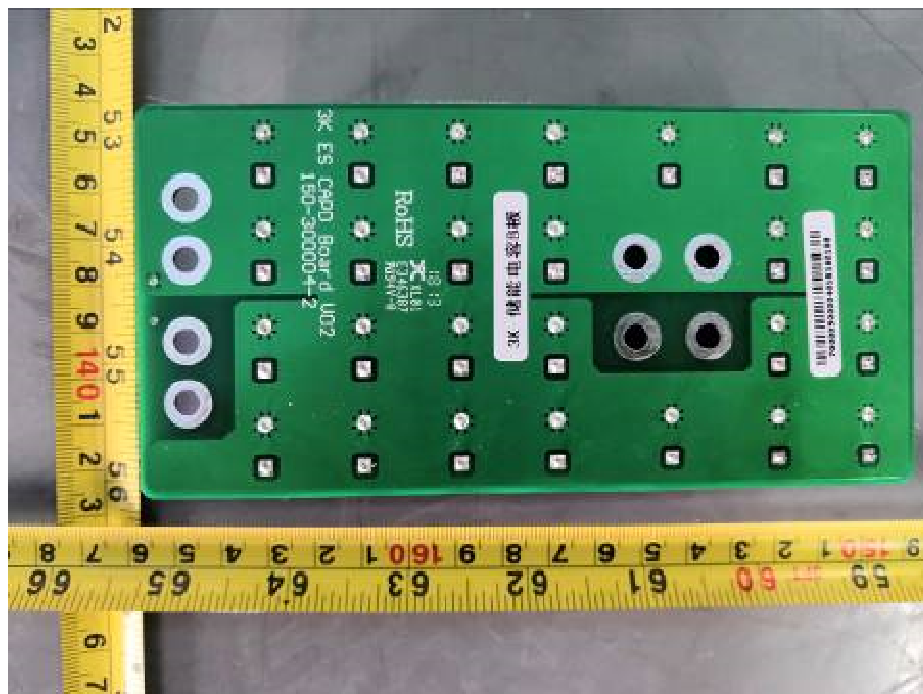



Capcittance A board component side view



Capcittance A board solder side view

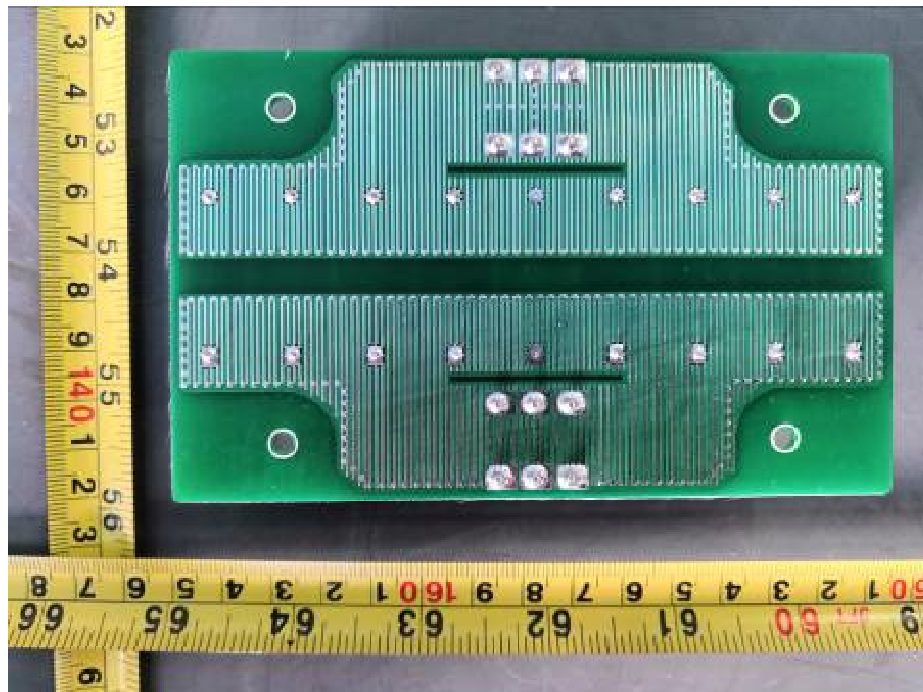



LCD board component side view

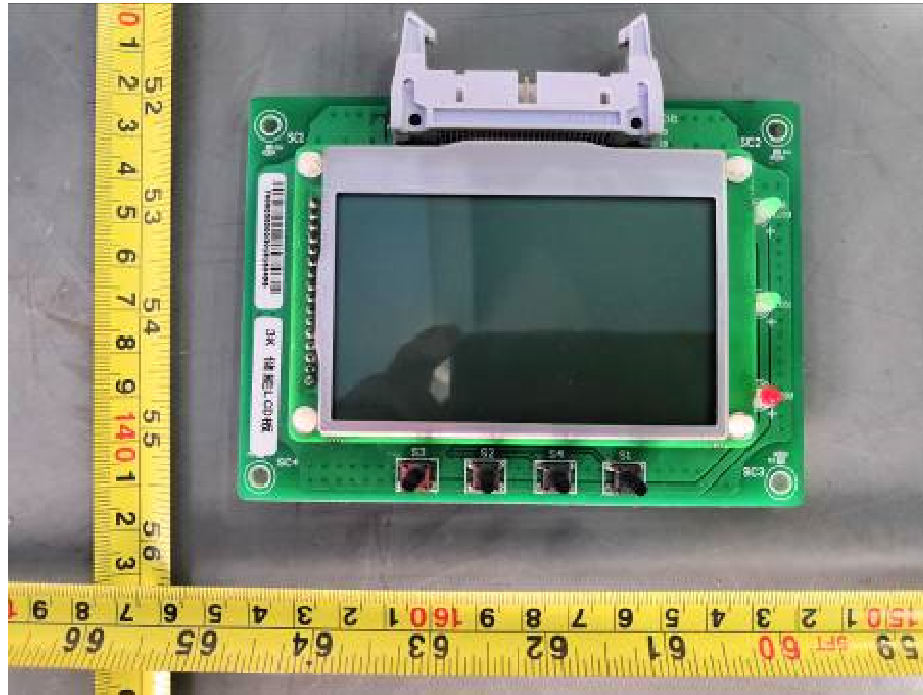

LCD board solder side view

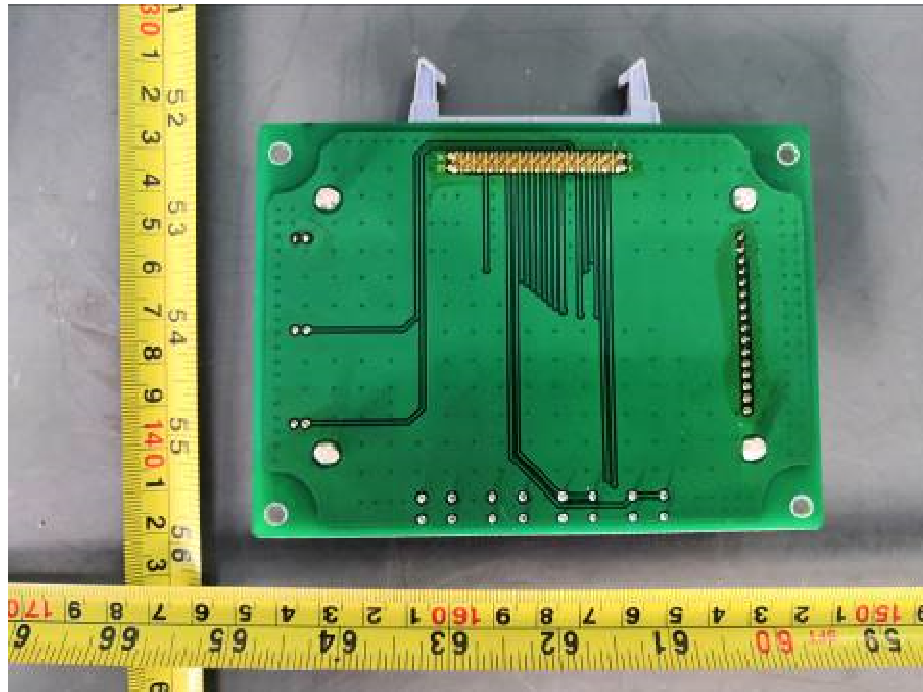



RS232 board component side view



RS232 board solder side view

